

# DELTA GREEN FUTURE/PERFECT 1

DELTA GREEN: FUTURE PERFECT 1

## Part 1 of a Delta Green Campaign

*Wherein terrible secrets unravel the skein of time*

ALL TEXT IN THIS PDF IS ©2006 DENNIS DETWILLER. DELTA GREEN AND ALL RELATED CHARACTERS ARE ©2005 THE DELTA GREEN PARTNERSHIP. THIS IS A FREE, NOT FOR PROFIT PDF. THIS PDF MAY BE PRINTED AND BOUND FOR PERSONAL USE ONLY.



## FUTURE/PERFECT PART 1 HELLBEND, CALIFORNIA

By Dennis Detwiler

### Introduction An Overview

Future/Perfect is a series of investigations linked together to form a single unbroken campaign. However, each investigation is self-contained and can be run as a one-off adventure.

The campaign is a great way to introduce new players to the world of Delta Green. They can be brought in completely ignorant of the conspiracy, or with some foreknowledge.

In any case, I hope you enjoy it. Thank you for contributing to the patronage system — which makes this product possible. Visit [www.detwilerdesign.com](http://www.detwilerdesign.com) to contribute to new Delta Green products.

### Welcome to Hellbend, California, Population 82 A Nice Place to Die

Hellbend was once a vibrant town of nearly 3,500 souls, back when Hunt Electrodynamics ran the show. It was in the middle of nowhere, out past Beatty Junction near Death Valley, and no one knew why it was built there. In fact, no one cared.

In the late 1940's, Hellbend produced a third of the electronics found in fighter aircraft around the world. Hunt Electrodynamics ran everything from the schools, the town general store all the way down to the funeral parlor. The company provided everything; and the people liked it that way.

Victim	Clifford Potter (58 yoa)	Lucille Mayer (38 yoa)
Race/Gender	White Male	White Female
Occupation	Retired Metal Worker	Artist
Height	5'10"	5'2"
Weight	165 lbs.	102 lbs.
Time of Death	6 to 9 PM March 5, 2005	Between April 24, and May 8, 2005
Discovered By	Jarvis Greene	Lt. Joshua Orrino Nevada State Patrolman
Body Found	2.3 Miles from Town	112 miles from Hellbend
Cause of Death	Blunt/Cutting Trauma	Blunt/Cutting Trauma
Family	Brother (deceased)	Emily Warren (Companion), Tanya Mayer (Mother)
Enemies	None	None

### The Victims: At a Glance

So far, the feds know only this: the two victims of the Hellbend killer were most definitely murdered. The two coroners (Dr. Abner White from Independence, California and Dr. Emmanuel Costa from Las Vegas, Nevada) have both failed to definitively identify the murder weapon.

Whatever ended the lives of Potter and Mayer, it was strong. White suspects heavy construction equipment; Costa does not agree though he cannot offer a better explanation. A powerful force sheared bones, and on both victims, the ribcage was smashed — crushed like a paper model. Entire limbs were missing on both victims.

Because both Potter and Mayer had apparently been subjected to extensive scavenger action (Mayer far more than Potter) it is hard to gain exact measurements from flesh of the weapon's effects on tissue. What few measurements were achieved point towards a two to five inch blade of some rough material — possibly a row of them; like a rake, hoe or other construction type tool.

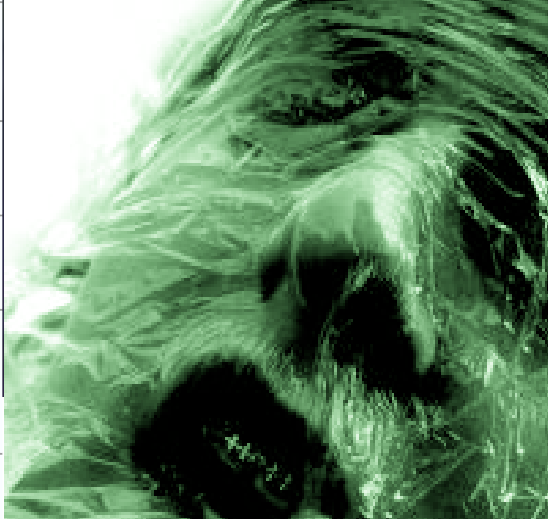

Then the explosion of 1952 happened and everything changed.

When the plant went up one August night, it took twenty-six locals with it, as well as the founder of Hunt Electrodynamics — the elusive Arthur Hunt.

In the midst of the destruction, Hunt Electrodynamics fell under new ownership and changed. Hellbend was left behind, crippled. The firm changed its name (Hunt Electronics) and shifted its attentions to the east coast — specifically NASA and the Pentagon.

Without the leadership of Hunt, who lived and worked in Hellbend, the town dried up like the earth

in Death Valley. People left, schools closed, things fell apart.

Fifty-three years later the town is nearly dead. Only eighty-two people call the crumbling remains of Hellbend home anymore, and those few don't look to the future. They get by on what they can, selling gas and goods to those on the way to the Death Valley National Park and biding their time. In another fifteen years, Hellbend will die a natural death, shriveling up in the 110° summer heat, leaving behind a skeleton of ruined buildings as a monument of some better time.

But in the last month, something else has been wearing away at the town, something decidedly unnatu-

## Bakersfield FBI and the Structure of the Investigation

The Bakersfield FBI Office is located at 901 Tower Road, Suite 207 Bakersfield, CA 93309. The nearly two-dozen agents here report to the Sacramento FBI Headquarters. They usually find themselves dealing with bank robberies, interstate business fraud, drug trafficking and other mundane investigations — multiple homicides do occur, but they are usually handled by local police. Both kidnappings and interstate transport of a body are relatively rare.

This case is inter-state however, and Bakersfield is the closest to Hellbend.

Special Agent-in-Charge Kevin Slotin runs the Bakersfield office, and the Hellbend case smells like a big investigation. He will keep close tabs on it, since it's the first significant murder case Bakersfield has seen in more than five years. Sacramento HQ is also watching closely, ready to step-in if they feel the case is bogged down. In short, the players are on a short leash, and must keep their "i's dotted and their 't's crossed, or face swift replacement from on-high. As they'll soon learn, this may have terrible repercussions on more than their careers.

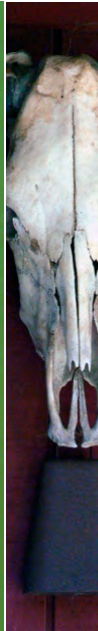

## Bakersfield's Relationship with the Sacramento FBI Office

Bakersfield is considered a small "appendage" of the Sacramento FBI Office (these external offices are called "Resident Agencies"). Since Sacramento is the capital of California, it enjoys more personnel, more attention, and more funding than the smaller Bakersfield office.

The Director of the Sacramento FBI Office is Special Agent-in-Charge Michael Turk, a man known for his particularly long memory and ability to recall, names, dates and Agent histories in seconds. Bakersfield's

Director Kevin Slotin lives in particular fear of him, and will do anything he can to appease him.

If, God forbid, the investigation into Hellbend goes south enough to generate media coverage, Sacramento, and more specifically SAC Turk will step in, with both feet.

The Agents, and more specifically Delta Green, don't want that to happen. Turk is a large and looming threat to the security of the Delta Green conspiracy.

ral. If the murder rate in Hellbend continues it'll die a lot faster than fifteen years, and a lot more violently than just another victim of some dead industry.

Someone or something is killing the residents of Hellbend, California. No one knows who or what it is.

## The Hellbend Investigation, May 12, 2005 Delta Green Moves In

The players are Agents from the Bakersfield office of the FBI. They have been assigned the Hellbend case following the second murder of a local resident of Hellbend.

The first murder occurred on March 5, 2005, on the outskirts of the town. Clifford Potter, a 53 year-old white male, was found mutilated less than four hundred yards from the remains of the ruins of the old Hunt Electrodynamics plant.

The county coroner from Independence, Abner White could not readily identify just how exactly he had died. No one doubts foul play of some sort — his body was torn to pieces — but no one can come up with a motive.

A nearby Bobcat light construction vehicle was tentatively identified as the murder weapon (since it was

covered in his blood), but few can understand how such an event occurred. Potter had rented it at his own expense and was digging around on the abandoned lot at the ruins of the Hunt plant for some unknown reason.

He was known as a local treasure-hunter; and was considered just a little bit crazy. Local investigation petered out after just a week.

The second victim, Lucille Mayer, a 36 year-old White Female, was reported missing in Hellbend on the night of April 24th, and was discovered by State Police over the border in Nevada fourteen days later when a local officer was drawn out into the desert by a gathering of buzzards. Very little to examine was left of Mayer, who was identified by her teeth. Serious blunt trauma had occurred, and portions of her skeleton were gone — missing. Nevada FBI was called in, and the Las Vegas coroner placed cause of death as violent blunt and cutting trauma — in other words; murder.

The physical evidence — what of there, there is — matches the marks found on Potter's body.

The case was officially placed under Federal jurisdiction with the Mayer murder and reassigned to Bakersfield FBI.

Bakersfield is confident that someone is murdering people in and around Hellbend.

### Are the Agents DG?

This is a question the Keeper needs to determine before the adventure begins. There are four options:

**THE AGENTS ARE MEMBERS OF DELTA GREEN:** This is the easiest solution, and works well if this investigation is to be run as a one-off adventure. In this case the normal routes of supernatural investigation are open to the Agents — they can call in help from A-Cell; use bizarre means to get the job done; and immediately explore possibilities that would be considered insane by normal Agents.

**ONE OR MORE OF THE AGENTS IS DG:** This works as well, and can make for interesting roleplaying as the knowledgeable Agents attempt to “break-in” those ignorant of the world of the supernatural. This also creates an interesting tension between players — with some in the know, and some on the outside.

**THE AGENTS ARE DG FRIENDLIES:** This works well if you want the Agents to have a whiff of the supernatural, but no definitive proof — as Friendlies they are open to the possibility of something more than science can explain, but may not have experienced such an event personally. It is also a good way to bring Agents fully into the DG fold over the course of the investigation.

**THE AGENTS ARE IGNORANT OF DG:** This adventure is a great way to introduce Agents to Delta Green; once they discover what they are dealing with, few will be able to deny the existence of the supernatural. See Delta Green at the Bakersfield/Sacramento FBI below for more details on how to set this up.

### Delta Green at Bakersfield/Sacramento FBI — T Cell

To introduce uninitiated Agents to the Delta Green, DG can either contact the players, or they can discover the conspiracy at work in the Bakersfield/Sacramento area. The leader of the conspiracy in the area Special Agent Clark Grunberg (Agent TAYLOR) will not be afraid to pull some strings to bring men in, if he thinks the mission calls for it. But he does have some local resources.

Another DG Agent (Kimberly Tralvayne) is employed at Bakersfield/Sacramento FBI, and a single DG friendly is an Agent at the Bakersfield office. Clark Grunberg brought the other two into the conspiracy. Only Clark is vaguely aware of the structure of the conspiracy, and will do his best to keep such information from new initiates.

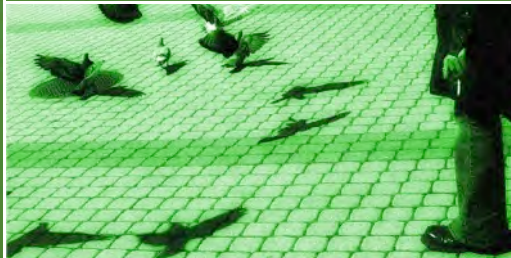

DG Agent	Special Agent Clark Louis Grunberg AKA TAYLOR	Special Agent Kimberly Tralvayne Meyer AKA TATE	Special Agent Lewis Makamura (DG Friendly)
Race/Gender	White Male 44 yoa	White Female 43 yoa	Asian/White Male 38 yoa
Occupation	FBI Special Agent — Sacramento FBI	FBI Special Agent — Bakersfield FBI	FBI Special Agent — Sacramento FBI (Forensics)
Height	6'2"	5'9"	5'9"
Weight	199 lbs.	181 lbs.	193 lbs.
Home Address	1081 West Hastings Drive, Bakersfield, California	9 North Sherman Street, Bakersfield, California	220 E. Yale Park, Bakersfield, California
DG Ops	-10SEP99 to 11NOV99 Investigation of Alien Activity -02FEB01 to 29NOV01 Investigation of Cult at Yosemite -15FEB02 to 21FEB02 Assisted C-Cell, pursuing <i>De Vermis Mysteriis</i>	-10SEP99 to 11NOV99 Investigation of Alien Activity -02FEB01 to 29NOV01 Investigation of Cult at Yosemite -15FEB02 to 21FEB02 Assisted C-Cell, pursuing <i>De Vermis Mysteriis</i>	-15FEB02 to 21FEB02 Assisted C-Cell, pursuing <i>De Vermis Mysteriis</i>
Weapon	S&W 1076 Semi-Automatic	Glock .40 S&W	Glock .40 S&W

## Hellbend History Past is Prelude

Hellbend California is little more than a bump in the road in the desolate wastes of Death Valley. The only thing that makes it unique in the area is that it's obvious it was once much more.

The remnants of a formerly vibrant company town are still to be found surrounding the core of what Hellbend has become. Derelict buildings, long abandoned and overrun by weeds and witch grass dot the roads leading up to town – Hunt Electro-dynamics legacy.

Once the town supported an entire workforce of nearly 4,000 people – and they left their dwellings behind. Most have fallen into near-complete ruin; windows long ago shattered, paint peeled off, decks collapsed, foundations shifted. Some, however, are still lived in and some are even meticulously maintained.

Besides this tiny core of inhabited buildings, the remaining areas of Hellbend were long ago surrendered to the desert (with a few small exceptions) and no one usually goes into these sections if they can help it. Since the murders, no one really walks there at all, if they can help it.

Most of the 82 residents of Hellbend live near the center of town or within a few blocks of Main and State streets. Others however live a bit off the beaten path – further out in the desert.

In any case, the only business worth mentioning is the Gas n' Sip – the local gas station/video store/supermarket/post office on the corner of Main and State. Nearly every piece of mail comes or goes through the Gas n' Sip and nearly everyone who stops in Hellbend does so for one of two things – gas or directions.

On a busy day a car or two will come through Hellbend on its way somewhere else. A scattering of locals will come or go to the Gas n' Sip, a few animals will be seen wandering around – a cat and a couple of dogs. And if it's a banner day, Jarvis Greene will close the Gas n' Sip early and play horseshoes with some neighbors in the lot out front the station.

The town is so small, it doesn't even have a police force — when the crimes occurred, officers from Beauty Junction had to be alerted by phone.

Hellbend, California	Facts
<b>Area</b>	799 acres (323.33 hectares)
<b>Population</b>	3,526 (1950 Census), 82 (2000 Census)
<b>Founded</b>	1940
<b>Industry</b>	Tourism (Formerly Military Electronics)
<b>Temperature</b>	High: 128 F (53.3 C), Low: 18 F (-7.7 C)



Death Valley	Facts
<b>Area</b>	3,367,627.68 acres (1,362,860.25 hectares)
<b>Highest Point</b>	Telescope Peak 11,049 feet (3,367.7 meters)
<b>Lowest Point</b>	Badwater -282 feet (-86 meters)
<b>Temperature</b>	High: 134 F (56.6 C), Low: 15 F (-9.4 C)

## Hunt Electroynamics (Hunt Electronics)

Arthur Hunt, a home-schooled genius from rural Ohio formed Hunt Electroynamics (now Hunt Electronics) in 1926. With three significant patents by Hunt in its first year of operation, the company was rapidly flush with capital. By the time radio and rural electrification had swept the nation, Hunt was already at the head of the pack — the Hunt Resistor was a standard electronic component in nearly every radio produced between 1933 and 1949.

With World War II, Hunt revenues exploded and the company grew to gargantuan proportions. By 1945, Hunt Electroynamics employed nearly 11,000 individuals across the U.S. In a move that would prove his genius, Hunt expanded his business into home electronics such as washing machines, refrigerators and freezers, as well as electric ovens. By 1948, Hunt was the second largest producer of such items behind Westinghouse.

In his lifetime, Hunt guided the privately held company in several odd directions; first, the company never went public. Secondly, though it did have large offices in both Los Angeles and New York, Hunt ran the business from the Hunt Electroynamics plant he had constructed at great expense in Hellbend, California; in the center of one of the most inhospitable places on earth; Death Valley.

Hunt rarely left Hellbend after 1940, and was the subject of some scrutiny due to his odd behavior. A legendary recluse, he spent the last decade of his life working on the design of a device that would “change the face of the Earth”.

In August 1952, at the age of 46, Arthur Hunt was killed in the explosion of the Hellbend Hunt plant. The plant was literally erased — and seemed to fold in on itself as the earth swallowed it whole. Nothing salvageable remained.

Hunt’s right-hand-man Thompson MacAfee assumed control of the company, purchasing Hunt’s privately held stock from his estate at an enormous sum. He renamed the company Hunt Electronics, shifted its headquarters to Washington D.C. and began actively reviving the military contracts which had been slipping in the first few years of the 1950’s.

H.E. became a primary resource of specific electronic components for the U.S. Air Force in September 1955. The company’s star rose along with the arc of the Cold War; and its revenues and work force exploded.

In 1977 Thompson MacAfee handed over the reins of H.E. to William Lassiter. Lassiter moved the company into the realm of home computing. By 1990, MacAfee’s move proved sound. H.E. was a premiere producer of computer equipment and components and as the Cold War shriveled, restructured itself to the demands of the new market.

The company remains an anomaly to this day. It is privately held and has been since its inception. William Lassiter is known as a recluse; much like his predecessors, and no one knows precisely which way the company will jump next.

### Arthur Hunt (1906 to 1952)

Hunt’s story is intriguing enough to be the subject of several books, a failed movie, and even a short-lived stage play.

It has all the classic elements, a home-town boy who makes good, eccentric behavior, a dramatic ending. In American business, there aren’t many old-timers who don’t recall the oddities of Hunt and his company.

Information about Hunt is varied and complex — two biographies paint Hunt as a mentally ill individual, obsessed with privacy and bizarre occult beliefs.

One biography examines the schism between Hunt’s young adult life—as the town drunkard—and his sudden transformation into a genius. Like Nikolai Tesla before him, Hunt seems to be one of the rare individuals who suddenly “understood” universal laws and became what the world at the time termed a “whiz kid”.

The movie—a 1955 B-Movie from Republic Pictures called *The Man Who Saw Tomorrow*—paints Hunt (ham-handedly) as a bizarre, brilliant futurist trying to change the world. It is loosely based on historical events, and contains special effects and acting so bad that it is nearly un-watchable. Nothing of interest can be gleaned from it.

The 1977 play—*The Boy from Ohio*—ran off Broadway for four weeks successfully before being closed by legal action started by William Lassiter; CEO of Hunt Electronics. Lassiter claimed the play was libelous, painting several HE employees in a poor light, and making Hunt out to be a megalomaniac. Basically, Lassiter used HE’s corporate might to crush the play.

The Hunt Museum still exists in Chester, Ohio—Hunt’s birthplace. It contains copies of all these books, a reel of the film, and even a copy of the play.

Otherwise, they are *extremely* difficult to come by.

## Clifford Potter Victim #1



Potter was born in Detroit Michigan, and worked at the Ford Auto Plant there for twenty-five years; taking early retirement in 1992 just two weeks before the plant was permanently closed. He had taken four vacations in those years, the last two to Death Valley national park – and Potter fell in love with the climate and area. He bought the house in Hellbend in late 1993 at a fire sale price and has lived in the town ever since. As such, he was still considered “new” by small town standards.

Clifford Potter was considered neither a nice nor particularly rude individual in town. He had no friends to speak of, but was known to help out others as needed. He drank, but not overly so, and seemed content with maintaining his house and hiking around the ruined areas of Hellbend recovering pieces of valuable scrap metal to sell in nearby Independence or Beatty Junction.

Late in 2003, Potter began poking around the Hunt Electroynamics plant; an area usually avoided by locals. It wasn't avoided it due to some haunted house legend—the site is just uninteresting; nothing more than a thigh-high sea of ruined concrete pieces.

Potter began digging up large portions of brass, bronze and copper piping from the site to make some extra money. He was often seen driving off to

the ruins of the plant in his old Ford truck with an acetylene torch and other gear in the back. It was common knowledge around town that Potter thought the ruins of the plant was a proverbial gold mine.

No one else in town really cared—and after awhile, Potter stopped talking about it.

### Clifford Potter's House 1.1 Miles out from Hellbend

Clifford Potter lived on the extremities of Hellbend near to what is commonly referred to as the “bluff” – a small rise in the land to the north west of town; approximately 1.2 miles from the ruins of the Hunt Electroynamics plant (placing it 1.1 miles from the center of Hellbend).

He was the only resident of the area for nearly a quarter of a mile in any direction, and seemed to like it that way. His small house was immaculately kept; in fact, it is the only clearly maintained house in the vicinity. Potter owned the home outright, and went to great lengths to keep it in prime shape; though nearly no one ever came out to see him.

It is a one-story, gable-roofed house painted a sickly, lime green. It has a small, hand-dug root cellar separated from the main building that drops approximately 12' into the ground, and a small 4' tall attic.

Inyo County Sheriff's Deputies searched it in a casual fashion, looking for signs of a struggle or other simple clues. Otherwise, it has largely been ignored. Law enforcement officials took nothing from the house – once they discovered the FBI had become involved – all local law enforcement support evaporated. There's not a lot of local law enforcement money to go around.

### The Kitchen Mundane Secrets

Potter's kitchen seemed to be the hub of his life. The rest of the house is military clean—sparse almost—while only the kitchen seems “lived in”. A sign over the stove says “You don't have to be crazy to live here, but it helps”.

The food is a series of tinned meat, chili and boxed

#### Clifford Potter (58 yoa)

White male,  
unmarried.

A retired metal  
worker from  
Detroit with no  
known ene-  
mies.

Known to dig  
around the  
ruins of Hunt  
Electrodynamic  
s Plant #004  
for scrap  
metal.



noodle dishes, all bought from the Gas n' Sip.

The real interest in the room lies on the table—the gloves, two books, a notepad, a map, a boom-box and a series of tapes.

### The Gloves Red Dirt

These beaten gloves appear to be heavy work gloves. They are covered in red dirt that does not match the local terrain. Anyone picking them up realizes they are indeed heavy. They are leaded gloves, purchased from a medical supply company in Winchester Idaho nearly a year ago. X-Ray and lab technicians who deal with radioactive substances on a daily basis use them.

### The Books Disturbing Implications

Two beaten books are on the table—*Radioactivity and Geology: An Account of the Influence of Radioactive Energy on Terrestrial History* and *Radioactivity and Its Measurement*. Both obviously deal with radiation, and were ordered from Amazon.com nearly two years prior. They are somewhat technical, but deal with the detection and identification of radiation sources.

They are well read, but are otherwise devoid of clues.

### The Tapes Heresay and Innuendo

Cassette tapes are strewn about the kitchen table of Potter's house, next to an ancient, nearly inoperable boom-box. Each has a chicken-scratch label marking them as "Monty Int." followed by a number. There are 24 tapes in total. They are not dated. Each contains the rambling recollections of Montgomery Greene (see Montgomery Greene on page 15 for more details).

The Inyo County Sheriff listened to one and failed to see their importance. Each captures a particular recollection by Monty Greene about when he worked in the once prosperous Hunt Electrodynamics plant for Arthur Hunt – the elusive multi-millionaire. They appear to have no direct relevance on the case, but appearances can be deceiving

### The Notepad Baffling Shorthand

A battered water-logged (but now dry) notepad is on the kitchen table as well. In it Clifford Potter took hundreds of notes – but few are clearly legible. Be-

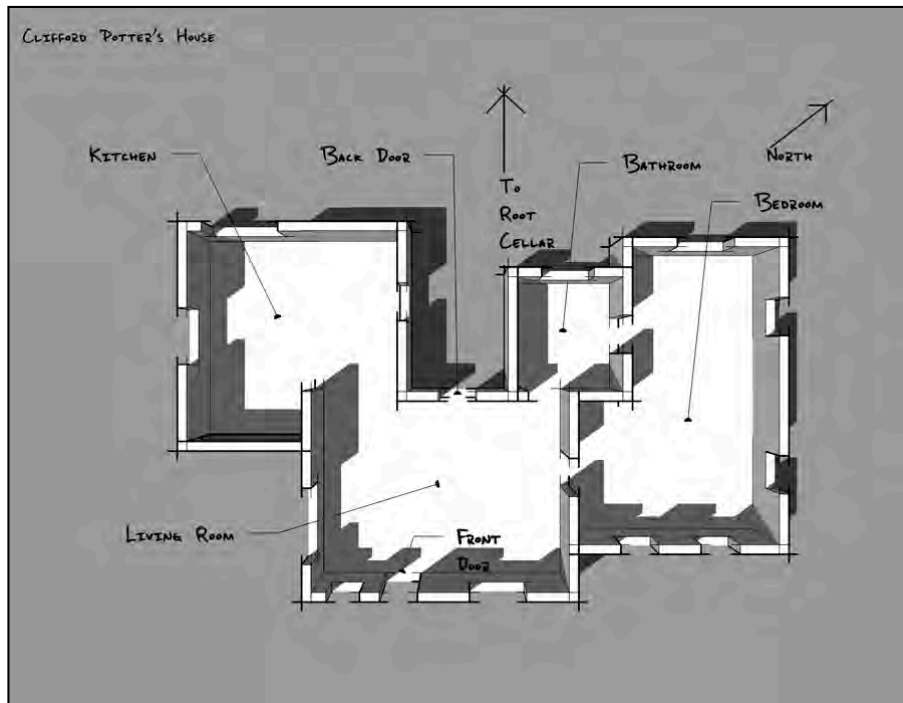



## Paranoia; It Comes with the Territory

Agents confronted with books on radiation and a dead man—particularly DG Agents—might jump to some conclusions. Encourage paranoia if any develops. Witch grass outside the house is brown and dead; did radiation cause it? (No, but it's fun to freak the Agents out).

Bringing a Geiger counter into the hours will yield some interesting (though thoroughly safe) results. While the house is clean for the most part, several areas read in the 3 to 4 REM range (the notebook and map), unusual but not overly dangerous.

The root cellar however, is another story. Even at the top of the stairs, the root cellar emits a strong 50 to 100 REM signature. This is dangerous enough to cause mild radiation sickness and even cause male sterility with prolonged exposure. The source is the center of the room, in the floor (see "The Cube" for more details).

This also offers up another serious threat—this one political. If anyone in the FBI outside of the conspiracy discovers such a strong radiation source at a Federal crime scene, they will report it to the Department of Homeland Security and within hours the place will be crawling with specialists sticking their noses into all parts of the investigation, looking for a dirty bomb.

The Moderator should do his best to make this obvious (or, if he's feeling mean, call for a halved LUCK roll from the Agent with the lowest score). See "The Real Feds Step In" on page 24 for more details.

sides the poor penmanship, it is obvious Potter had no need to label pages – instead, he seemed to be writing about something he knew very well. Most of the notes appear to be measurements of distance like (6'23"). Careful comparison of the notepad to the Map (see below) reveals some identical measurements used on the map.

Some notations are less obscure – such as "machine parts: gold, silver" and "radioactive?" are scattered on the pages as well. The last page shows a simple, hand-drawing of what looks like an odd pool with sockets in the border surrounding it. Wavy lines are drawn in the center of the pool (in actuality, this is not a pool, but the gate; see "The Gate" on page 20 for more details).

## The Map But of What?

This hand-drawn map is something obviously fashioned with great care by Clifford Potter. It shows what appears to be several passages from a birds-eye view along with careful measurements of distance and angles. It is not labeled.

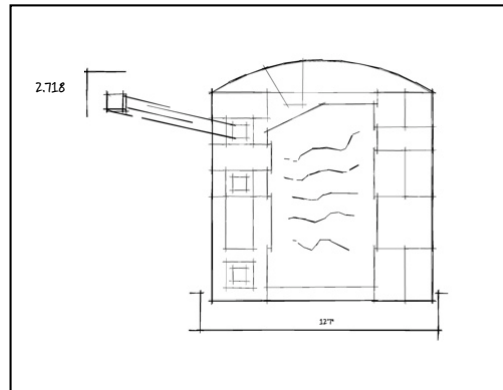

*The drawing on the last page of Clifford Potter's Notepad*

Those exploring the sinkhole at the ruins of the Hunt Electrodynamics Plant will soon uncover the fact that the sinkhole that covers the area matches the width and dimensions of the hole in the center of the map. The tunnels shown are not visible, however, and must be underground somewhere.

## The Root Cellar More Than a Hole in the Ground

The root cellar is a recent construction; something dug in the last two years. It is a small 10x12 room about 12' down in the ground, accessible through hand-made storm cellar doors and a series of slate steps. It appears as if a great amount of effort went into constructing it—locals will note Potter finished

it just after he began going out to the Hunt plant on a regular basis (this also coincides with the two books being ordered from Amazon.com). It appears completely empty except for a single long-toothed rake propped against a shored-up wall.

Careful Agents who hover on the stairs before entering and

make a successful SEARCH roll realize that only one person has been down in the soft dirt of the cellar (indicating that possibly the Sheriff's deputies did not enter—the sheriff will confirm this). It's also obvious whoever the footprints belong to, the person was interested in raking the floor of the cellar.

Those few footprints evident disrupt an otherwise perfect sea of carefully raked dirt; like a strange subterranean Zen garden.

### The Cube 14 Pounds of Trouble

This 2.718"x2.718" 14-pound solid gold chunk is machined into a precise, odd cube with curved corners, a slight curve on the inner faces and a strange icon carved into each face. By current standards, the cube is worth approximately \$65,000. It is buried in the dead center of the room less than a foot beneath the dirt, and is wrapped in a large zip-lock bag.

It is radioactive, emitting 50 to 100 REMS. If the Agents don't know this, prolonged exposure to it (holding it close to the body for say and hour or more) will cause their CONSTITUTION to drop by 2 points and give them a general feeling of malaise (much like the flu). An IDEA roll is necessary to identify the culprit. Once identified, if it is safely contained, stats eventually return to normal (though at the Moderator's discretion lasting health effects might occur, such as sterility).

The icons on the side of the cube are each different, and are relatively unidentifiable—they are rectilinear, mathematical-like symbols. A linguist or ancient writings expert (roll appropriate skill here) can identify it as a language known as *Aklo*, but only after a protracted period of digging on the internet (see about *Aklo* on page 11 for more details).

If these symbols are shown to Montgomery Greene, he will identify them as symbols identical to Arthur Hunt's "code" (see "The Want Ad and Hunt's Eccentricities" on page 16).

If translated the symbols mean:

- **Asa** ("The West", "The End", "The Last")
- **Suu** ("The East", "The First", "The One")
- **Shé** ("The Between", "Transitional", "The Middle")
- **Sek** ("The North", "Above", "Up", "Cold")
- **Sesh** ("The South", "Below", "Down", "Warm")
- **Shi** ("Time", "Before", "The Predecessor")

Careful examination of the cube by an engineer (ENGINEERING skill of more than 20%) reveals it

was made with cutting-edge 1950's era metalworking machinery.

### The Meganeura Dragonfly More Valuable than Gold

Buried next to the cube is a huge glass jar filled with a thick, clear liquid (formalin—a formaldehyde like substance for preserving samples). Inside it is a HUGE insect, a dragonfly that measures approximately 29 inches from tip to tail. Its wings are crushed (two are missing) and it has obviously suffered severe trauma. It is curled in its death position in the liquid; rolled up like a spiral.

Anyone seeing this suffers (-0/1d4 SANITY). Those with knowledge of prehistoric life—ARCHAEOLOGY, ANTHROPOLOGY, PALEONTOLOGY or 20% or more—suffers (-1/1d6 SANITY) and can immediately identify it as what is thought to be the largest insect ever to exist on earth, a Meganeura Dragonfly.

The only problem with this amazing discovery is the Meganeura Dragonfly lived in the Carboniferous Period, some 300 million years ago. But the sample is as fresh as if it was killed yesterday. The value of such an item is incalculable; people would literally kill to obtain it. Needless to say, this is the kind of thing DG exists to cover up. If anyone outside the conspiracy discovers this, things could get bad, quick.



*The 14-pound Radioactive Gold cube*

## “Aklo? What the Hell is Aklo?”

Research on the glyphs found on the cube will lead to some odd informational sources. A serious researcher with a history in language studies is necessary to track down such leads however — without some skill in the area, information on the glyphs is non-existent, at best. Those who successfully use a skill (GRAPHOLOGY, LINGUISTICS etc...) to look into the meaning of the glyphs can locate several interesting sources on the subject.

### Source: Internet

On several obscure websites such as [www.glyphforge.net](http://www.glyphforge.net) and [www.inhumantongues.com](http://www.inhumantongues.com) information on similar glyphs can be located after 3 to 5 days of searching. The language is apparently called “Aklo” and arguments rage as to its validity. Some claim it is the tongue of creatures that existed before humanity—others that it is a modern-day fake, created to generate interest in the occult.

None of these sites mentions what kind of creatures these pre-humans might be. But they all reference a single existing source of the Aklo tongue—the so-called “Federal Papers” located in the special collection at Miskatonic University in Arkham, Massachusetts. PDF copies of the Federal Papers are easily found on the internet—they are filled, front to back, with symbols identical to those on the cube. The copies are generally good, but lack extreme detail; some symbols are dim, others cut off, and the vague impression of notes scribbled on the pages can sometimes be seen, though never clearly read.

### Source: Library of Congress

Two mentions of Aklo can be found in the Library of Congress after 2 to 3 weeks of searching. One is from a 17<sup>th</sup> Century text on American Indians, *On the People of the New Land (Boston, 1699)*, which is a study of American Indian tribe legends of pre-history. An Indian (unidentified) speaks of the “Aklo” people—men of great size who could control minds, vanish from sight and who disrupted the Indian tribes in “the west”. The second book is a 1921 volume called *Tongues of the Precursors (New York, 1921)*, this sensationalist text refers briefly to the “Aklo (also called ‘Tsath-Yo’) tongue of the sorcerers”. It is otherwise unhelpful.

### Source: Miskatonic University, Special Collection

Access to the “Federal Papers” is by special appointment only (FBI Agents should have no problem making an appointment).

These papers, recovered in 1935 from the belongings of the vanished writer Robert Blake were donated to the library by local authorities. Once part of a book, they are now loose sheafs of old vellum paper kept in a folio, separated carefully by plastic guards.

Their validity has been questioned on several occasions, and it is common scuttlebutt among those who study such things that Blake himself—a writer of weird tales—created them to generate interest in his fiction. However, Agents who go to the trouble of seeing the papers in person will find a reward; on the 12<sup>th</sup> page is a single, English handwritten line in faded pencil (not visible in the online resources)—it is a solution to the cipher of Aklo, broken by Blake in 1935 before his disappearance. Any linguist with access to this cipher can crack the Aklo tongue in a matter of hours.

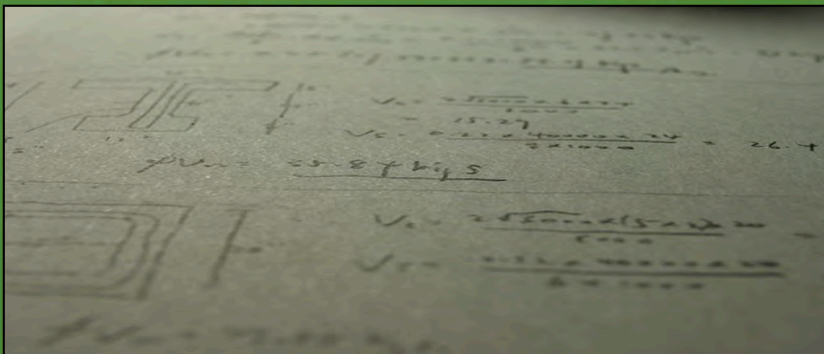

## Lucille Mayer Victim #2



Born in Los Angeles California in 1969, Mayer spent most of her adult life in and around the UCLA School of Arts and Architecture; first as a student of pottery, and later as a teacher.

In 1999, Mayer met Emily Warren, a painter from Death Valley who sold canvases in L.A. twice yearly. After a brief affair, Mayer and Warren moved into Warren's home in Hellbend. They lived there together as a committed couple for the past six years. Mayer sculpting, and Warren painting. They supported their leisurely lifestyle by selling works in Las Vegas and L.A.

Both Mayer and Warren are considered friendly, affable individuals by the townsfolk, and are well liked. Even if they are commonly referred to as “the lesbians”, this is more an indication of the tiny size of the community, as opposed to some slur—beliefs in the town are liberal considering the age of its population. Few gave them a second glance.

Since 2001, Mayer had been creating popular “desert wood” sculptures; assemblages of desert dried wood and other plants, woven together into complex designs. To this end, Mayer spent much of her free time (particularly dawn and dusk) walking the perimeter of the town, collecting wood. She never went much further than a half a mile out of town, and was not known to be skilled at survival. She was

a cautious individual, not known for taking risks.

Warren alerted the sheriff within an hour of nightfall when Mayer failed to return—the town rapidly organized a search, but any signs of her tracks were quickly obliterated by the harsh climate. A painful wait continued for several days until her body was located 112 miles from Hellbend, in the Great Basin in Nevada by Lt. Joshua Orrino, a Nevada State Patrolman.

### Emily Warren The Significant Other

Emily Warren was Lucille Mayer's life-partner, and the two enjoyed a rare and trouble-free relationship. They coexisted in such a manner as their life was seamless—they simply got along. As can be expected Warren is extremely distraught by Mayer's death. She is considering leaving Death Valley altogether, and cannot imagine life without her lover.

Warren is completely innocent of any wrongdoing, but any Game Moderator who wants to ratchet up the red herrings may do so (see Warren's Brother on page 12 for more details). Otherwise, Warren is of little help. Her house (a small two bedroom structure near the Gas n' Sip) is devoid of clues.



### Lucille Mayer [right] (36 yoa)

White female, unmarried.

A sculptor from Los Angeles.

Known to walk the perimeter of Hellbend to look for scraps of dried wood for her sculptures.

### Warren's Brother

A background check with the National Crime Information Center (NCIC) reveals Emily Warren's brother Christopher Warren (41 yoa) is a felon with multiple convictions for violent crimes, including assault, and attempted murder.

If Emily is asked, she confesses her brother lived with them, briefly and she finally kicked him out when he became violent, injuring Lucille in a minor scuffle over a 20-dollar bill.

Christopher is currently couch-surfing with friends in Malibu. If located he has an iron-clad alibi—literally—he spent two weeks in the county lockup for failing to pay child-support to one of his many children. Those two weeks coincide with Lucille Mayer's disappearance and the discovery of her body.

## Items of Interest People and Places



### The Inyo County Sheriff Death Valley Office

This small "Death Valley Office" of the Inyo County Sheriff is located at Hwy 190, Death Valley, California 9232. It maintains a two-man on-and-off crew that rarely sees any criminal activity in the area. These two men work out of a glorified shack perched on the side of Highway 190 with little more than a two-line phone, a ham radio set and a sloth-like internet connection.

### Alfred Mann, Sheriff Out of his Depth

The sheriff responsible for the "investigation" is Alfred Mann – a ten-year veteran of the area. Mann likes Death Valley and is a common sight patrolling the roads in his beaten up Jeep cruiser. He is well liked and thought of as a fair individual.

Despite this, Mann is not properly trained for the investigation he has found himself embroiled in. Mann's search of Clifford Potter's house was, at best, shoddy and his report on the murders are incomplete and obviously show a man out of his depth. Luckily, Mann is not an egotist, and will be the first to admit this. He is eager for Federal involvement in the case despite how "ineffective" this may make him seem to the county officials.

Mann will assist the FBI – if asked – but will otherwise stay out of the way; in the hopes the experts can bring the killer to justice.

### Lucas Androzy, Deputy Sheriff Too Big for his Britches

Lucas is a bit more judgmental than Sheriff Mann—he's young, headstrong and more than a little ticked off that the Feds have stepped in. Though his heart is in the right place, he tends to stick his nose where it doesn't belong. He'll show up (smiling the whole time) at spots the Agents are searching; ask questions of witnesses who were questioned by the Agents; and complete searches after the fact, trying to cut the Agents off at the proverbial path.

This is more from a worry of not doing a good job than from some deep-seated hatred of Federal

authorities. Androzy was the official first out to the murder site of Clifford Potter, and was the first to "search" his premises. His policing skills however were not up to the task—his training began and ended with traffic stops. Murder is way out of his league, but two years of *CSI: Miami* has convinced him differently.

### Involving the Sheriff and Deputy

Both Alfred Mann and Lucas Androzy are prime candidates for DG-Friendly status. They are unmarried men who live alone, and whose job allows them access to intelligence and weaponry. They can also very effectively quash rumors, reports and crimes in the isolated region of Inyo County.

They will not be easy to convince however. Exposed to obviously supernatural events (say, confronted by the creature killing those in Hellbend) it's an easy sell. But more subtle things—such as the 14-pound gold cube or the Meganera Dragonfly—will be less convincing to some.

While Sheriff Mann will immediately grasp the importance of both, Androzy will feel some sort of trick is being played on him. Unless he's shown absolute evidence (or Sheriff Mann is convinced) it'll be hard to bring Androzy into the fold with anecdotal evidence.

Once in the fold however, the two will be invaluable backup. Both have lived in the region their whole lives, and are well versed in desert survival, hunting and the ways of the locals. Everyone knows and trusts them.

### The Gas n' Sip The Only Game in Town

The Gas n' Sip is a two-story (plus basement) rickety looking building with a gable roof that sits on the corner of Main and State streets, dead-center in Hellbend. It's adorned with aging Coke signs, ancient ads for Brylcreem and other less memorable products long since washed out by the relentless sun. There are two, old gas pump placed dead center on a simple concrete block out front, and not too far from them, Jarvis Greene—the current proprietor can usually be found; generally lounging in the shade of the roof.



Inside, the front room (which was once a parlor) now serves as the store. On the buckling, uneven wood floor, two enormous refrigerators hold perishable foods, ancient military surplus racks hold potato chips, canned foods and other nitrate-filled treats. A tiny register area—nothing more than an old desk with a 1940's cash register precariously perched on it—sits in the corner beneath one window, overlooking the pumps.

Past the store is a long hallway that leads to a bathroom, a door to the basement, a rickety staircase upstairs, as well as a small kitchen in the back. The two rooms upstairs are the small, slope-roofed bedrooms of Montgomery Greene (the aging owner) and Jarvis (his 22 year-old grandson). During the day, these rooms boil, at night they freeze.

Montgomery, who is in his nineties, can often be found in the kitchen, bathroom, or moving up or down the stairs at a snail's pace (in fact, going up or coming down often takes him an hour or more). He doesn't usually go into the store if he can help it, and leaves the daily grind to Jarvis.

People come and go from the Gas n' Sip in the casual nature of small town folk—they often go inside without even saying hello to Jarvis, use the bathroom and leave. No one at the Gas n' Sip seems to mind.

Only recently has Jarvis Greene begun locking the doors of the store at night.

## Jarvis' Secret

Jarvis Greene left Albany for more than one reason. It's true he didn't much care for school, but he also has an outstanding warrant for drug possession issued just two weeks before his move west. A New York State Trooper busted Greene while he was carrying a modest amount of marijuana on his person. Luckily, it was a small enough amount that when Jarvis made bail, he was released and told to report for a hearing the following month. A day later, he received the letter from his grandfather.

Any Agent checking on Greene's past in the National Crime Information Center (NCIC) (maintained by the FBI) will find this New York state warrant - indicating that in New York, Jarvis is a wanted man.

Even worse, Jarvis brought his habit and knack for growing with him. In the basement of the Gas n' Sip, the remains of a grow-op can be found. For months, Greene grew several large pot plants below his grandfather's feet and sold it to some residents of the town (though getting anyone in town to admit this will be very difficult). Following the discovery of Potter's body however, Jarvis panicked and rushed home to dispose of his grow-op before notifying the police.

Any Agent examining the basement who makes a successful IDEA roll notices strange and recent additions to both the water and electrical systems in the basement, and that unlike the rest of the house that is cluttered the basement seems relatively empty.

## The Missing Four Hours

Agents spending any amount of time poking into the time surrounding the discovery and reporting of Clifford Potter's corpse will notice a discrepancy of nearly four hours between the time Jarvis Greene returned from the Hunt Electrodynamics Plant and the call to the Inyo county sheriff.

The phone calls; as well as Jarvis' own statement foolishly confirm the fact - a twenty minute drive back from the Hunt Plant site somehow took Greene four hours. In actuality, Jarvis drove straight back, cleared out his pot plants and grow-op equipment and only then called the Sheriff.

This discrepancy will likely draw a cloud of suspicion down on Jarvis, who actually had nothing to do with the incident. Still, a clever Game Master can extend this red herring out until it seems very plausible that Jarvis had something to do with Potter's death.

## Jarvis Greene (22 yoa) Local Pot-Head

Jarvis Greene is a young, sunburned hippy who has lived with his elderly grandfather since 2001, taking over the local Gas n' Sip business when his grandfather could no longer maintain it. The two live together in the cramped apartments of the smallish building.



Greene grew up with his parents in Plattsburgh New York and attended SUNY Albany for a year before dropping out to move to Hellbend. Needless to say, his parents are not pleased with the situation. Jarvis' father, William, grew up in the heyday of Hellbend, when Hunt Electrodynamics ran the show, but has few fond memories of the place—hence his dramatic exit at an early age for the east coast.

Jarvis only heard of his grandfather in passing before he received a letter from him in 2001. Greene took it as an opportunity to find a future other than the dull grind of school. He finds Death Valley and Hellbend particularly relaxing (or at least he did, before the murders) and enjoys his duties at the Gas n' Sip. He even enjoys his granddad's company.

Jarvis spends most of his day sitting in a weather beaten rattan chair out front of the station waiting for cars or customers. He hands out mail, sells about thirty to fifty dollars worth of food to locals from the small grocery section of his shop, and maybe twenty to thirty dollars worth of gas every two or three days, on a good week. Besides that, he reads old paperback novels, plays checkers with his grandfather, steps inside to play a few games of *Grand Turismo*, or outside for a game or two of horseshoes with the locals. He is well liked and respected, despite his counter-culture appearance. People still think of him "as the new kid at the Gas n' Sip" despite him living in town for four years.

Jarvis knew Clifford Potter and discovered his body at the ruins of the Hunt Electrodynamics plant outside of Hellbend—in fact, it was Jarvis who rented Potter the Bobcat Lifter for the afternoon. When Potter failed to return that evening with the equipment, Jarvis took his Jeep out to the site and found him. From there, the Inyo county sheriff was alerted. Jarvis saw a lot of Potter in the months leading up to his death—the retired metal worker had taken to interviewing Jarvis' grandfather Montgomery Greene about his personal experiences in the

Hunt Electrodynamics Plant before its destruction in 1952. On several occasions, Potter taped his grandfather's recollections, and asked specific questions about Hunt and the plant, though what they were, Jarvis can't recall.

## Montgomery Greene (98 yoa) Old as the Hills

Montgomery Greene was born in Carlsbad California in 1907. Following his discharge from the Marines in 1933, answering an ad in a newspaper, Montgomery found himself face to face with Arthur Hunt—the elusive and cagey multi-millionaire—his life was tied to Hunt and his company for the next twenty years.



Hunt's company was just taking off, and Montgomery found the man fascinating. Greene was able to endure even the most terrible abuse hurled by Hunt, who insulted him non-stop during the initial interview; but almost in a casual way, as if he didn't really understand what constituted an insult at all. Greene had developed an immunity to such abuse during his time in the Marines, and found it routine, even soothing to be back in a familiar situation. Hunt needed a personal assistant—a glorified go-pher—to do a very specific series of things for him, without wavering.

For twenty years, Greene did as he was told and was one of the few people in Hellbend to see Hunt on a regular basis; Hunt even seemed to care for him—something unheard of in Hunt's world. Greene moved to Hellbend when the plant was constructed, and moved into a lavish house built on company funds (the current Gas n' Sip). Greene paid nothing for the house or the land—each was silently granted to him when he renewed his contract the year the Hellbend plant opened.

## Clifford Potter, Monty Greene and the late Arthur Hunt Weirdness on Tape

Since Potter's initial discoveries underneath Hunt Electrodynamics Plant #004, he became obsessed with uncovering the secrets of Hunt's research. The only living person in Hellbend who knew Hunt was Monty Greene. For the last year and a half, Clifford Potter conducted extensive interviews with the old

## The Want Ad and Hunt's Eccentricities

The ad in the Carlsbad Examiner answered by Montgomery Greene in the summer of 1933 is still perfectly preserved in the old man's memory, as are most of his memories prior to 1965.

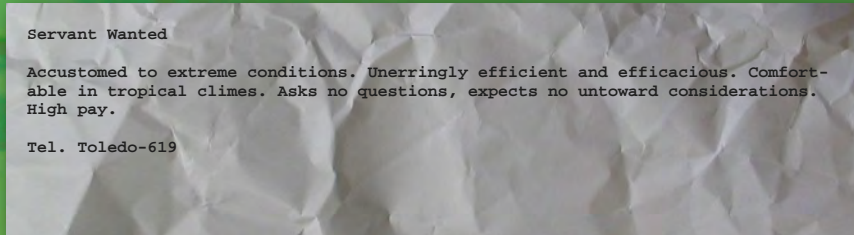

Greene, who had served in Central America during his stint in the Marines though the job sounded ideal. He found Hunt abusive at first, but once he discovered how Hunt "liked" things, he found the man – whom all referred to as a tyrant – almost generous.

Montgomery Greene will freely talk about Hunt and his eccentricities:

- Hunt refused to move anywhere in the plant without specific lighting arrangements. This usually meant two large floodlights with an aluminum reflector placed at even intervals in a room and lit before he even entered. Few could take the heat generated by such lamps, but Hunt seemed to thrive in it. He refused to move into rooms that were not like this unless they were absolutely dark. He seemed quite comfortable in the dark.
- Hunt was completely eidetic, and recalled with perfect clarity anything he read, heard or saw. He could draw exact duplicates of things he had seen only once, and never used a ruler or guide. All his plans were drawn by hand with no tools, yet they appeared perfect.
- Hunt wrote in a code of odd mathematical symbols. He did so he claimed to keep his most classified projects a "secret".
- Twice, Greene heard Hunt exclaim in a language he could not identify – it sounded like "some Polynesian or South Seas lingo".
- Hunt slept only rarely (Greene can only recall seeing the man asleep *once* in nearly twenty years of service).
- Hunt read three to five books a *day*. Even while maintaining a grueling schedule of product design, Hunt had Greene gather specific books for his perusal. Early on, Hunt focused on politics, religion and current events. Later on the military, the history of world conflict and the disposition of the post-war world.
- The sight of blood infuriated Hunt. No one knows why.
- Hunt ate only carefully prepared vegetables. He ate copious amounts of cleaned, but otherwise unprepared vegetables once a day. He would only eat vegetables prepared by Greene, and seemed to "know" when Greene had prepared them.
- Hunt's office in Hellbend was *heated* and lit from all angles by specially made recessed lights. Hunt spent the better part of his time in Hellbend in this room, only very rarely venturing out.
- Hunt wore a thick pair of specially made Bakelite "goggles" when going outside. These goggles were tinted a deep yellow and Greene carried an extra pair with him at all times.



man, in the hopes of uncovering something about the oddities he found beneath it.

For the most part, Monty Greene remains ignorant as to what Potter was poking around to discover. To Greene, Hunt was a demented genius who was somewhat creepy, but otherwise, nothing special. Monty enjoyed the company, and is more than willing to repeat what he told to Potter (if he can recall it).

For more information on the interviews, see “The Monty Greene Tapes” on page 27.

## The Bobcat Light Construction Vehicle

This small, one-man, propane-powered vehicle was designed for light digging, lifting and plowing. It is the only one in town; owned by the Gas n’ Sip and rented out for small local jobs. Clifford Potter rented the machine on various occasions – once to dig his root cellar, and the second time, to poke around the Hunt Plant.



The Inyo county sheriff returned it two days after Potter’s murder; still dirty with Potter’s blood and marked up with various bodily fluids, fast on their way to evaporating.

Jarvis Greene attempted, half-heartedly to clean the vehicle, but lost his appetite for the job shortly thereafter. It now sits around back of the Gas n’ Sip in the shade of a garage port, stinking up the area.

The vehicle is still in working condition, and any Agent examining it and making a successful IDEA roll realizes that it is highly unlikely that the vehicle was the murder weapon that killed Clifford Potter. For one, the blood and effluvia is on the side of the vehicle, not the digging blade – meaning Potter would have had to be struck by the vehicle on the side. Even at top speed (just over 5 MPH), the Bob-

## The Biological Samples

### The Feather-Like Sample

This odd feather-like item is actually a portion of a giant scale – it is a cluster of small orange buds that seem to sprout something like the end of a feather. It is not immediately evident what kind of creature could have produced such a biological sample; even to those skilled in ZOOLOGY. DNA examination of the sample (which will take 5 days) identifies it as from some sort of bird, though an exact identification cannot be made. It is actually a portion of a scale from the Monolophosaurus – the creature that killed Potter – left behind when the beast rubbed its scent glands against the Bobcat lifter to mark its territory.

### The Clear Liquid Sample

This substance is obviously urine of some sort dried to a thin sheen. DNA and protein analysis of the sample (which will take 2 days) cannot readily identify the source; though it does appear to be from some sort of large warm-blooded animal. The sample also contains two protein chains never before seen in science. No definitive answers can be gained from this examination except “whatever it is, it eats meat”.

cat could not have inflicted the wounds found on Potter in this manner. The only truly dangerous portion of the vehicle – the blade – is untouched.

The marks of blood and effluvia on the side of the vehicle are odd. Though they are long dry; they are clearly visible as several distinct “layers”. As if something applied several layers of biological material on the vehicle. Anyone with ZOOLOGY or BIOLOGY can roll their skill ÷2. On a success, they recognize this type of marking as a territorial or scent marking common in large predatory animals. It seems as if a large animal rubbed against the vehicle repeatedly; spreading Potter’s blood on it.

Also, the smell present at the vehicle is something exceptional – it is not just the smell of blood cooking in the Death Valley sun. It reeks of ammonia and other, less-identifiable smells. A clear liquid has dried to a thin, shiny sheen on the surface – it is not a human body fluid. Agents taking a sample of this substance can have it examined easily, though few of the locals will understand what the point is.

Greene’s cleaning attempt did one thing – it removed a single, odd feather-like scale from the Bobcat. It is now under the vehicle, teetering on the edge of a slot-drain sunk into the floor. It is not readily visible to anyone poking around the vehicle;

and requires them to move the Bobcat or to carefully search the ground beneath it. If they do this, they can make a SEARCH roll to locate the bizarre sample.

## The Ruins of Hunt Electrodynamic Plant #0004

### Ground Zero

Located approximately 2.3 miles from the center of Hellbend, California on the ruins of a formerly beautiful asphalt road, a sea of destroyed concrete is all that remains of the Hunt Electrodynamic plant #0004. A partially ruined chain link fence surrounds it 500 yards out from the ruins on all sides—it is hardly a deterrent, large gaps exist every fifty feet or so.

There are several odd things about the ruins. Agents with ENGINEERING of 20% or more may roll to identify some anomalies. A successful roll reveals that the plant was likely not destroyed by an explosion, but a collapse. A success by 20% or more indicates the plant was destroyed by an *implosion*. Some great force pulled the building inwards.

All that remains are concrete slabs split into no larger than three-foot chunks, an occasional metal strut curled by some huge force, random, destroyed business devices from the 1950s. Walking the site of the plant reveals little. There are no apparent entrances below, no tunnels, holes or stairs down. The site appears barren.

The point where Clifford Potter was digging with the Bobcat is easily found. This 20'x30' bald spot has been meticulously cleared of rubble, and is covered in Bobcat tracks, various footprints and random items (such as candy-bar wrappers, soda cans etc...) Beneath the rubble is a red dirt that matches the gloves found on Clifford Potter's kitchen table. The Bobcat blade broke the ground maybe once or twice, and the hole it created dips down only a foot or two, revealing nothing.

The site is suspiciously clear of anything else. Where Potter could have been "digging up metal pipes" is unclear (unless they were on the surface). There are no metal pipes—no metal at all except steel—on the surface.

Whether this means Potter stripped the site or he found the metal somewhere else remains unclear. Smart Agents will immediately begin searching the outskirts of the plant.

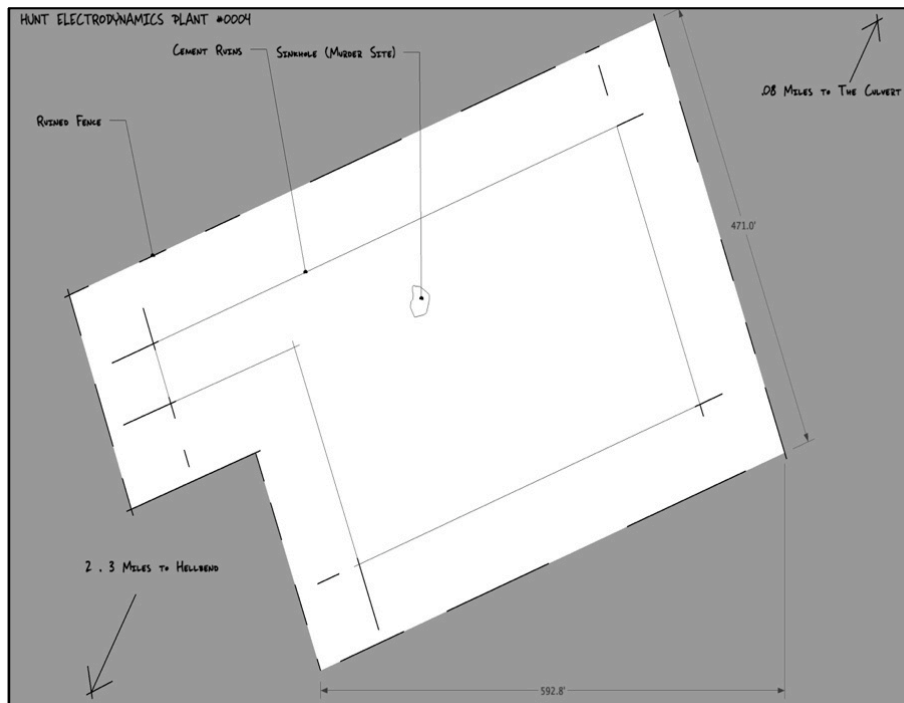

## The Real Site

### The Culvert

Located a .8 miles to the northwest of the ruins, where the land drops two dozen or more feet is a culvert connected to the subterranean structures of the Hunt Plant. The culvert is an 12'x12' concrete tube that protrudes from the hill, and disappears into the depths of the ground that leads back to the site.

The culvert is awash with a spray of greenery—small plants with a single red flower on them that grow in dribs and drabs on a delta like stream of water which pours out into a fan, disappearing into the parched earth about 5 yards out. The area smells rich and damp. Anyone with a naturalist skill (BOTANY etc...) who makes a successful roll realizes this is all highly unusual.

### The Print

#### A Warning

A partial print of the Monolophosaurus (see “The Killer” on page 23) exists in the mud of the culvert. This huge print is easily mistaken for a natural occurrence for those not looking for something highly unusual. Agents must make a halved IDEA roll to see it at all, if they don't carefully search the area. Those wandering into the area without following SEARCH protocols must make a LUCK roll (lowest in the party) or ruin the print.

The print itself is HUGE, but only shows the ball of the creatures' heel. If a latex cast of the print is made and examined by a forensics expert (someone with FORENSICS of 20% or more), they can tell that, whatever it is, it weighs between 1200 and 1300 pounds. Nothing further can be gleaned from the print, except it doesn't make any sense.

### The Flower

#### Out of Time

The tiny red flowers (none bigger than a quarter inch) represent a baffling oddity, but only upon close examination by someone with BOTANY in excess of 20%. They are of a phylum never before seen. They seem to be somewhat primitive—vascular, fern-like plants they reproduce by spore, not by seed. Their plants are fragrant but leave a bitter aftertaste in the mouth of those who smell them.

Observant Agents (those who make a SEARCH roll) will also notice a preponderance of bugs flying around the plants. Careful examination of the

ground surrounding these flowers will find spore-covered corpses of hundreds of bugs. The plants secrete a chemical that renders the bugs unconscious, where they are slowly covered by spores, creating a rich growth medium.

Samples of this flower will cause quite a stir at any facility of higher learning; though it can be easily explained away (it won't be nearly as destructive as say, the discovery of the Megancura Dragonfly).

### In the Hole

#### Down in the Dark

The concrete culvert, which leads into the earth heading towards the Hunt plant, is quite large (12'x12'), capable of allowing a human to stand upright comfortably. Those that make a successful LISTEN roll in the hole can hear an odd noise. It is not easily describable—it sounds somewhat like an echoey clicking. It rises and falls over time. It sounds mechanical or electronic.

The culvert has a slow rush of water about 2 inches deep (it's warm), and its walls are covered in a deep green moss up to about hip height. The water seems to go in cycles—rising slightly in speed and depth every few minutes.

### The Geiger-Counter

#### Clifford's Contraption

This contraption, connected by a series of thick wires to Sears Die-Hard battery sits in the cave propped up on an overturned orange crate. It is the source of the ghostly, echoing clicking. The device seems to be the old innards of a radio rewired to some other purpose. Anyone making an IDEA or KNOW roll can determine it's a Geiger-counter.

Potter constructed it after his first extended foray into the tunnels made him ill, and he came to the conclusion that he was suffering from some sort of



radiation induced illness. Two other discarded Die-Hard batteries (drained) are dumped to the side of the tunnel. It's obviously been here a long time.

The machine spits out tiny clicks through a single, hand-wired speaker. These clicks increase or decrease with time; sputtering away in a sudden onslaught of noise, then just as suddenly fading to a barely audible click.

Those listening carefully to the clicking over time (more than 2 hours) and who make a successful IDEA roll, come to the conclusion that there is some sort of pattern to the clicking. Every 27 minutes it spikes, and every 11.5 minutes after that drops to almost nothing. This gives the Agents 15.5 minutes of relatively "clear" air in the tunnels to search, before the radiation spikes again. This pattern is very predictable, and can be easily timed.

Those that venture into the tunnels during the downswing of a spike are subject to serious radiation poisoning. Each target in the tunnels during that period must make a CONSTITUTIONx2 roll or suffer 1d6+2 HPs damage and be wracked with nausea, fever, headaches and general malaise for the next 1d6 days. Initially however, they seem fine; these effects occur minutes, hours or even days after the exposure. The particulars remain up to the Game Moderator to determine.

Those foolish enough to ignore the Geiger-Counter altogether and who spend more than one "upswing" in local radiation must make a CONSTITUTIONx1 roll or suffer 1d10+2 HPs damage, and *permanently* lose 1d20 CONSTITUTION points in the same manner as above. If they lose more CONSTITUTION than they possess, they die of severe radiation poisoning. Covering this up will be difficult—any emergency room will recognize and immediately report the signs of severe radiation poisoning (see *The Real Feds Step In* on page 24).



## The Caves Beneath Winding Passages

The culvert winds its way beneath what was once the Hunt Plant, finally opening into a larger, open cement room (approximately 30'x44') awash with water and odd plants. The culvert was once a drainage tunnel for the large room it now opens into, but damage from the 1952 explosion blew the reinforced concrete wall in and has now made a single jagged space out of the two areas.

Agents must scale a series of jagged ruined concrete constructions (now wet with warm water) into the larger room. (The GM can call for a DEXTERITYx3 roll; those that fail suffer 1d4 HPs damage.)

The caves and main gate room are quite large—much larger than would be expected. Those looking back on the area can clearly determine that a large predator; even a 15' long one, could easily make its way through the gate, down the tunnel and out the culvert. But then again, hindsight is always 20x20.

## The Gate The Source of the Disturbance

The gate is a 12'7" wide by 12'7" tall stone archway with slots on the left hand side of the large portal; it is tilted forward at a 12° angle, pinned in place by debris.

The stone is odd—it is a deep black soapstone-like substance with an almost metallic quality, unidentifiable by modern science. These slots each fit a 2.718" gold cube—the top slot is empty (this is the source of Potter's cube). Though almost the entire archway is clear of debris, as well as the topmost cube slot; much of the gate is obscured by rubble. Due to its geometric construction however, it is clearly implied that there are other cube slots beneath the rubble; how many is not clearly evident.

The other two slots hold two identical cubes, buried beneath extremely heavy portions of ruined steel girders, stone and masonry. There is evidence of someone attempting to dig down to these cubes (Potter). The gate matches perfectly with the drawing in the last page of Clifford Potter's notebook.

The gate itself is fascinating. The archway is filled with a deep gray mist; much like steam, which does not seem to drift far from the door. There is something odd about the way the smoke drifts; it occasionally seems to swirl, twist and congeal into tiny storm-like collections of clouds; and it never drifts

far from the stone doorway before evaporating. Those observing it for the first time must make a SANITY check or lose 1d4-1 SANITY. It is *obviously* not natural.

Photographic and electronic equipment more complicated than a pocket calculator immediately fail within visibility range of the gate.

Every 3.5 minutes, a stream of clear, warm water (barely an inch deep) pours from inside the gate. This continues down the tunnel where it exits out of the concrete culvert. When this occurs, the strong smell of a verdant jungle fills the tunnel (1d6-1 SANITY).

Initially, the gate was buried during the collapse, but subtle shifts in the space/time continuum occurred over the decades as one of the cubes used to control the device shifted slowly out of alignment.

On October 9, 2003 the gate spontaneously activated, after the cube found by Clifford Potter dropped out of place naturally. This accidental acti-

vation burned off the last bits of power that caused the 1952 malfunction. For a brief period, due to this flux, the Carboniferous and Jurassic periods were connected in an unbroken gate to the 21<sup>st</sup> century.

The underground explosion that occurred went unnoticed by the town at large (there was a measured seismic event, but it was so small as to be nearly undetectable)—but it cleared a large portion of the tunnels of debris. Furthermore, the gate was now active, creating a cycling link between various periods of Earthly history.

## Gate Travel Into the Breach

Those foolish enough to attempt to *step through* the gate deserve what they get. The gate currently fluxes between two periods in time: the late Jurassic period, nearly 150 million years ago (the source of the water, flowers, the Monolophosaurus and the smell), and the Cambrian period, nearly 542 million years ago.

### Life in the Jurassic Period

Those unfortunate Agents who find themselves in the Jurassic period immediately suffer a 1d10+2 SANITY loss when they realize the swirling mist of the gate *does not exist on the far side—there is no way back*. Even after the fixed time period of 3.5 minutes pass, the gate does not reappear; travel through the gate is one way. Congratulate them; they are now a fossil in training.

They find themselves in the midst of a lush, fern-covered valley standing in a small stream. It is incredibly warm and humid.

The landscape is covered in conifers, cycads and all sorts of huge and nearly alien looking ferns. Huge bugs buzz about, and will have no problem attempting to feast on an Agent (1d4-2 HPs damage), SANITY loss 0/1. The area is awash with all sorts of life including obviously long-extinct life forms.

Occasionally, something huge and lumbering will smash through the dense jungle. Those avoiding these sounds (this is easily done) can survive for maybe a day or two, after which they succumb to various ailments caused by ancient bacteria, protozoa and other microscopic life inimical to human life. Due to dehydration and diarrhea, their death will be prolonged and painful.

Those who search around too long (instead of staying put and laying low), make some noise or head towards such sounds encounter an Allosaurus, Monolophosaurus or some other terrible creature; and a very quick end to their life.

### Life in the Cambrian Period

As above, the Agent arrives in an alien environment, and as above, there is no way back. Agents immediately suffer 1d10+2 SANITY points of damage as they realize they are trapped.

The environment is bizarre. The sky is a deep and clear purple, drifting up to black. The air is thick, humid and warm. The Agent finds themselves in an endless run of shallow pools, raised portions of dirt crawling with tiny marine organisms like tiny fiddler crabs and distant, jagged peaks. Hanging above, improbably close to the earth is a huge, smooth moon; hardly touched by meteor impact.

Though they most likely have no clue, high levels of radiation are bombarding them (this time period is the source of much of the radiation in the tunnels beneath the plant). Within hours, their bodies will begin to die, and they will perish from severe radiation poisoning, 542 million years before they were born.

But now (unlike the event which reactivated the event) gate travel is one-way. Though the plants and animals came through the gate, it is now only possible to *enter* the past, not return from it.

Both periods represent incredible dangers for anyone foolish enough to step through the gate. Those stepping into the gate immediately lose 1 POWER point permanently and are transported to one of the two time periods.

## The Equipment Homemade Help

A stack of Clifford Potter's equipment is scattered around the small cleared out area surrounding the gate. It is sitting on top of a pile of rubble, well out of the way of the small stream of water.



It consists of an army bag filled with various ruined pieces of electronic equipment. There is a Sony camcorder which does not work (every single piece of electronics inside of it is ruined by some sort of electromagnetic flux), a tape recorder suffering similar symptoms and even an old flashcube Kodak camera filled with completely over-exposed film showing nothing (due to the radiation); strangely enough, this camera is set on a timer and tied to a 5' long stick.

## Using the Gate

The gate is a travel device to the past. The initial attempt to activate it in 1952 led directly to the destruction of the Hunt Plant; but this explosion "burned off" much of the excess energy produced by the poorly manufactured gold cube. It was designed to travel to one time period, the Palaeozoic, 279 million years ago—the height of the Serpent People culture—though due to errors in its construction, it cannot "tune in" on the period. (This error also led to the first malfunction).

Living creatures entering the gate are immediately "sucked" through at the cost of 1 POWER point. Non-living material can be pushed through and pulled back through the gate without difficulty (as long as the Agents' flesh does not touch the mist).

Clever Agents may attempt to "rescue" trapped Agents on the far side of the gate by throwing supplies, a rope or some other crude rescue device through (just as Clifford Potter attempted to photograph the period with a camera tied to a stick). There is a major problem with this however; since the last shift on October 9, 2003, due to the non-Euclidean nature of the gate, every "breach" into the time period occurs several microseconds *before* the last. Agents on the far side will never see another breach; they represent the last and only breach into that time period; previous breaches *never catch up*.

The three gold cubes, each marked six symbols control what time-period the gate opens into. The gate always opens on earth, and always in the same position (though the time-period differs). It is powered by the energy contained within living creatures (POWER).

Closing the gate is as simple as removing the other two gold cubes, or inserting Clifford Potter's gold cube in the empty slot with the Asa ("The West", "The End", "The Last") Aklo symbol pointing outward. If this is done, the mist vanishes instantly and a ruined wall of metal and stone can be seen on the other side of the arch; also, the radiation which once bathed the area immediately stops.

Suggestions for the effects of placing Clifford Potter's cube in position with any of the other five symbols remains are covered below.

☐**Suu:** The room immediately begins to heat up at an amazing pace. Within a minute, it's 140° in the room, and those who remain must make a CONSTITUTIONx2 roll to not pass out. Those who fail to retreat immediately suffer 1d6 HPs damage a *round* until they retreat (even those who pass out). Eventually, the heat rises to the point where the gold cubes melt and the gate fails.

☐**Shé:** There is a "pop" as the cube is put in place. Nothing seems to change, though the radiation and water cease to fill the tunnel. This is an interim setting; a "stand-by" if you will. The gate is dormant but ready to be activated.

☐**Sek:** There is a boom and air begins to be sucked through the gate at a high rate. Everyone present must make a DEXTERITYx3 roll or lose their foot-

ing and suffer 1d4 HPs damage. Eventually, as the pressure slowly increases, the tunnel begins to collapse in on itself. In 2 to 3 minutes the entire culvert collapses in on itself. Anyone inside it is killed. The gate is effectively closed.

**CSesh:** The gate opens underwater at some point in the past. An explosive wave of seawater fills the room in seconds, knocking Agents off their feet. Agents must make one INTELLIGENCEx2, one DEXTERITYx2 and one CONSTITUTIONx2 roll each—otherwise they are drowned in the flash flood. Those that make these rolls are washed out into the culvert on a wave of seawater. Closing the gate at this point becomes and impossibility; and the real Feds will most likely arrive shortly, as tons of seawater begins to fill the desert in the middle of Death Valley.

**CSHi:** Ripples in time/space rock the room. The tunnel begins to shift as the room shudders in an odd mix of an earthquake and random time-lapse photography. Agents are subjected to bizarre relativistic effects—things seem to stutter, slow, speed up or even stop. Agents must make an IDEA roll to escape, riding these effects like a rip tide in time. Within minutes, the rift closes as the tunnel collapses. Anyone still in the tunnel at the time is killed.

## The Killer

### Adaptable and Deadly

The Hellbend killer is not human; it is a fugitive from the Jurassic period—something that came through the fluxing gate in the ruins below Hunt Electrodynamics Plant #004.

## Monolophosaurus

### Very, Very Hungry

**Appearance and Behavior:** This small dinosaur is a cousin of the Allosaurus and is a striking red-green color. At first glance, it looks like an enormous flightless bird the size of a pick-up truck. Its small forearms are sprinkled with orange-green feather-like extrusions as is its back. It is quite obviously a killer—its head is filled with two-inch long serrated teeth, and its face is broken by one blunt horn. Its small forward arms also are tipped with five-inch hook-like claws.

It is also most definitely not a lizard. It is warm-blooded and obviously related to birds more than ophidians. As such, it's fast and when it wants to be, quiet. It's a skilled hunter on the par of a large lion

or bobcat, and can track, scent and stalk nearly anything with ruthless efficiency. It's nocturnal and sleeps in any dark cave it can find. It generally can be found prowling about within an hour of sundown up until two to three hours before sunrise.

Like any predator, it marks its territory—both with scent glands located on its face near its horn (which left the blood marks and anomalous material found on the Bobcat lifter at the first murder scene), and with urine. It considers the culvert to the rear of the ruined Hunt facility, its “home” and hunts in a large circle of nearly 130 miles surrounding Hellbend, avoiding the town proper. Since a run-in with a car alarm in Hellbend on its first night in the twenty-first century, it has avoided the town, preferring to hunt on the periphery of Hellbend and in the wilderness of the National Park. It does not like the smell of gasoline engines and vehicles and avoids them when possible.

It is not fearless—it lived in a time where bigger most definitely was better, and it learns quickly to avoid things that are larger, or louder than it. It can be rapidly dissuaded from a meal through both sound and pain—a decent shot with a large-caliber bullet can send it elsewhere to look for easier prey. A single car alarm was enough to permanently dissuade it from entering Hellbend itself.

Still, seeing a 15.5-foot bird-creature running around will be more than enough to send even the most stoic Agent scattering. Few will think very clearly when confronted with a throwback from the Jurassic era, particularly in an area like Death Valley, which is riddled with caves, hills and canyons large enough to easily hide such a beast. In short, the Monolophosaurus is completely at home in Death Valley and as long as humans keep wandering into its territory, is quite content to remain indefinitely.

**Length:** 15.5 feet (5 meters)  
**Skull Length:** 24 inches (63 cm)  
**Weight:** 1,344 lbs. (0.6 Tons)  
**Period:** Jurassic (206 to 144 million years ago)



## Complications

### A Normal Night at the Opera

This investigation is filled with booby-traps that poorly prepared or slow thinking Agents will probably trigger. Got an Agent stupid enough to report discovering a 14-pound radioactive gold cube, or a 300 million year old 29-inch long dragonfly? Or do they just rush in like a bull in a China shop and overstep their legal authority? Here's what happens, when, and why.

## The Real Feds Step In

### One Step from the Bronsons

Agents pushing the envelope of their legal powers will soon find themselves dealing with FBI Special Agents sent to keep an eye on them. First, an "advisory agent" will be assigned to the group of DG Agents—this Agent will never be more than a few steps behind them, taking notes and poking their nose into all aspects of the investigation. This will make "borderline illegal" things much harder to pull off.

Until the Advisory Agent sees something supernatural (such as, say a 15.5 foot long dinosaur running around Death Valley) it will be very difficult to get anything done. When they do see something that falls into the realm of the unexplained, have the Agent with the lowest LUCK score make a roll. If they succeed, the Advisory Agent is onboard with



keeping the situation quiet, if they fail, they report it to their higher ups, and things get much, much, worse; MAJESTIC steps in.

If the Agents report radioactivity of *any sort*, an entire FBI task force (along with a mobile command center) will show up. The Department of Homeland Security will be alerted, NEST teams will begin combing the town for other sources of radioactivity, and the story will make national news.

Once the NEST teams discover the gate, the story will fold as MAJESTIC steps in.

## MAJESTIC

### Men in Black

If any of the oddities in this investigation—the dragonfly, the gold cube, the radiation, the dinosaur—are reported to the real authorities (as opposed to say, Delta Green) MAJESTIC will become alerted.

They will approach the problem through official channels as investigators from the National Security Agency and play the old "National Security" card. Agents will be instructed to cooperate to the best of their abilities by Sacramento FBI. MAJESTIC has dealt with thousands of bizarre occurrences such as this, and their investigative arm is more interested in removing "provocative" materials than actually digging into the heart of the matter. They will miss everything except what they are directly handed or lead to.

Those failing to cooperate will find themselves "strong armed" by both their superiors at the FBI and by the NSA goons themselves. Threats of a career cut short, pensions severed and internal investigation will be hurled. Those that resist will find these threats very real.

If the Agents send the names of the NSA Agents up the chain to A-Cell, they will find their credentials in order, the only oddity is this—each of the IDs was issued within the last two weeks. In actuality, the NSA Agents are NRO Delta operatives; highly effective and deadly killers bent on containing the truth and recovering alien artifacts at any cost.

If their hands are forced, the NRO Delta operatives will kill and cover up the murders of the Agents; but this is only if there is absolutely no other outcome possible. They haven't remained the most tightly guarded secret in the history of mankind by poorly thought out, rash, action.





### Michael Grunning's Background

Michael Grunning was a normal 17-year old high school student from Fargo North Dakota who disappeared just days before the Agents interfered with the gate. He was a quiet, happy kid who worked at the local grocery, lived with his mother and drove a 1976 Ford Duster.

His disappearance is highly suspicious, and is major news in Fargo. If he's discovered alive in Hellbend, the story will vanish relatively quickly (happy news is rarely harped upon). If, however, he's killed by Federal Agents in Hellbend, the shit will hit the fan. (See *The Real Feds Step In* on page 24.)

## The Great Race Operative Out of Time

Agents who begin fiddling with the gate (those who send a living occupant through or try other cube combinations) will soon be pursued by another force, the Great Race of Yith—alien entities that can hurl their minds through time and space. The Great Race send a mind of one of their operatives to occupy the body of a 17-year old High School student from Fargo North Dakota—Michael Grunning—and send this operative to Hellbend to make an adjustment to the gate.

The Great Race is concerned with preserving a precarious timeline that, in the distant future allows them to escape from the past into the hive-like minds of Colcopterans. The Agent's gate activation has made a minute change that has sent that timeline spiraling off course. The Great Race operative means the Agents no harm, but will do what is necessary to get the job done.

Observant Agents might notice Grunning on a halved IDEA roll. The young man can be seen around Hellbend just hours after the Agents interfere with the gate (the Great Race send him back *before* the interference occurs, so he's already in Hellbend when it occurs). Grunning is blank-faced and odd looking. His clothing is mismatched, and though he seems to understand English perfectly, his voice has a strange uncertain lilt to it.

Grunning has set up shop outside of Hellbend in a rotted out Ford Duster he has driven from Fargo North Dakota. Inside is a mish-mash of various gutted and reconstructed consumer electronics; warped by the incredible minds of the Great Race into technology centuries ahead of modern Earth.

Grunning will attempt to make his way to the gate unobserved (something which the Agents have hopefully made a bit more difficult than simply walking out there), and will set up an elaborate electronic device outside of it. This device is composed of used sewing machine parts, a microwave oven, some intercom equipment and a home computer. This device is supposed to "offset" whatever damage the Agents caused, restoring the Great Races' timeline.

Whatever the machine is; if the Agents discover it, it is obvious it is more than some weird toy. The blinking lights, odd cycles and movements the mechanical elements make are as precise as a Swiss clock. The computer equipment can be tracked back to Michael Grunning in Fargo, North Dakota. After several hours of cycling in front of the gate in such a manner, the machine will cease working and refuse to work ever again. Nothing significant can be gleaned from it except "it's complicated".

If confronted and an attempt is made to detain the Great Race operative, the creature will pull no punches. He will reveal what looks like a hybrid garage door opener and cell phone held together by duct tape and open fire on the Agents with this "lightning gun".

Due to his odd discomfort in human form, the Great Race operative will most likely be easy to kill; if this occurs, the Great Race keeps sending operatives until their mission at the gate is complete.

If however, the operative in Grunning's body manages to "treat" the gate, it will leave the body of the 17-year old, and Michael Grunning will wake in Hellbend, Nevada, 1700 miles from his home, terrified.

## Spoilers for Future/Perfect The Skinny

Just what is going on in the overall campaign arc of Future/Perfect? Good question. Note that the following explanation is a bit of a spoiler, so keep it from your players. Also, it's not necessary for the Moderator to know what is going on in the overall arc (in fact, sometimes it's better if he doesn't!) so the Moderator may skip this section if he likes.

In 1923 an uneducated small town drunk named Arthur Hunt decided to dig up one of the smaller Serpent Mounds in Chester, Ohio. Native Americans constructed these mounds some time in the distant past, and many locals believed there was treasure to be found in them. Amazingly Hunt discovered a gold sarcophagus in the mound, almost as if he was *drawn* to it. Instead of containing further treasure, it held the slumbering form of the Serpent Man Xichlasi trapped in a stasis for nearly two thousand years.

Freed from the spell that held it in place, the creature rose up and consumed Hunt and through inhuman magic assumed his form, becoming him. Realizing that mammals had long since overrun the globe Xichlasi set about creating a gate back to Antediluvian Earth, home of the Serpent Man civilization. In such an uncivilized time, the task would take decades.

To the outside world, it appeared Hunt—considered a garrulous idiot by most—had suddenly become a reclusive, incredibly intelligent individual.

“Hunt” absorbed most of the Chester, Ohio library in a matter of weeks and quickly understood the primitive hegemony the mammals had forged in the modern era. “Hunt” formed the company Hunt Electrodynamics and began his stellar rise to power as a business owner patenting dozens of devices that were considered ahead of their time by the humans (in fact, the devices were the most rudimentary Serpent Man technologies).

The entirety of the company was formed for a single purpose—the construction of the gate that would allow Xichlasi to bring other Serpent Folk from the distant past to the modern Earth. By 1940, “Hunt” had constructed the facility in Hellbend, California in which it would construct the gate (it had chosen this location also for its temperature; which its ophidian biology found more comfortable than Ohio).

A small group of humans understood a bit of what “Hunt” was up to—the sheer volume of materials and components needed for the gate required hu-

man accomplices. None truly understood the purpose of the device or “Hunt’s” true identity; though a few had their suspicions. One of these men, Thomspen MacAfee knew that something about Hunt was unnatural and that the device he was building in Hellbend defied Earthly science.

In 1952, “Hunt” was ready to activate his gate—unfortunately one of the specially constructed cubes that formed the portal had been machined improperly. The human that constructed it was off by a few microns—the results were disastrous.

The portal activated and due to the flaw, immediately failed, tearing the fabric of space/time in two; instantly rending the facility in two and killing everyone inside it; Xichlasi along with it. The remaining cubes were buried in the rubble of the factory and forgotten.

MacAfee, who had assisted “Hunt” in the creation of the device, now used the illegal materials “Hunt” had somehow gathered (including nearly a ton of gold from an unknown source) to purchase the company. MacAfee became certain after perusing what remained of Hunt’s other designs in the New York office, as well as his odd collection of antique books that something decidedly paranormal was going on. He had long suspected something was wrong with “Hunt” and had twice seen things that confirmed such suspicions. By the late 1960’s with further research into the area, MacAfee was convinced Hunt was not human at all—and was instead some sort of extraterrestrial.

MacAfee set about reproducing the device “Hunt” had been building in the desert. He had, after all, been “Hunt’s” right-hand-man, and had been involved in the Hellbend project from its inception. The plans and specifications for the device were left in Hunt’s safe in New York.

By 1977, when William Lassiter took over Hunt Electronics, the new gate was well underway and Lassiter fully understood its implications. The small town of Duxbury, Pennsylvania was the home of the new gate. By 1986, the gate was active, and Lassiter and his company were exploring the depths of terrestrial history, traveling back in time to epochs completely unknown to man. Hunt Electronics, though the advent of Alien science, had unlocked the secrets of time.



# Handouts for Future/Perfect 1

## The Details

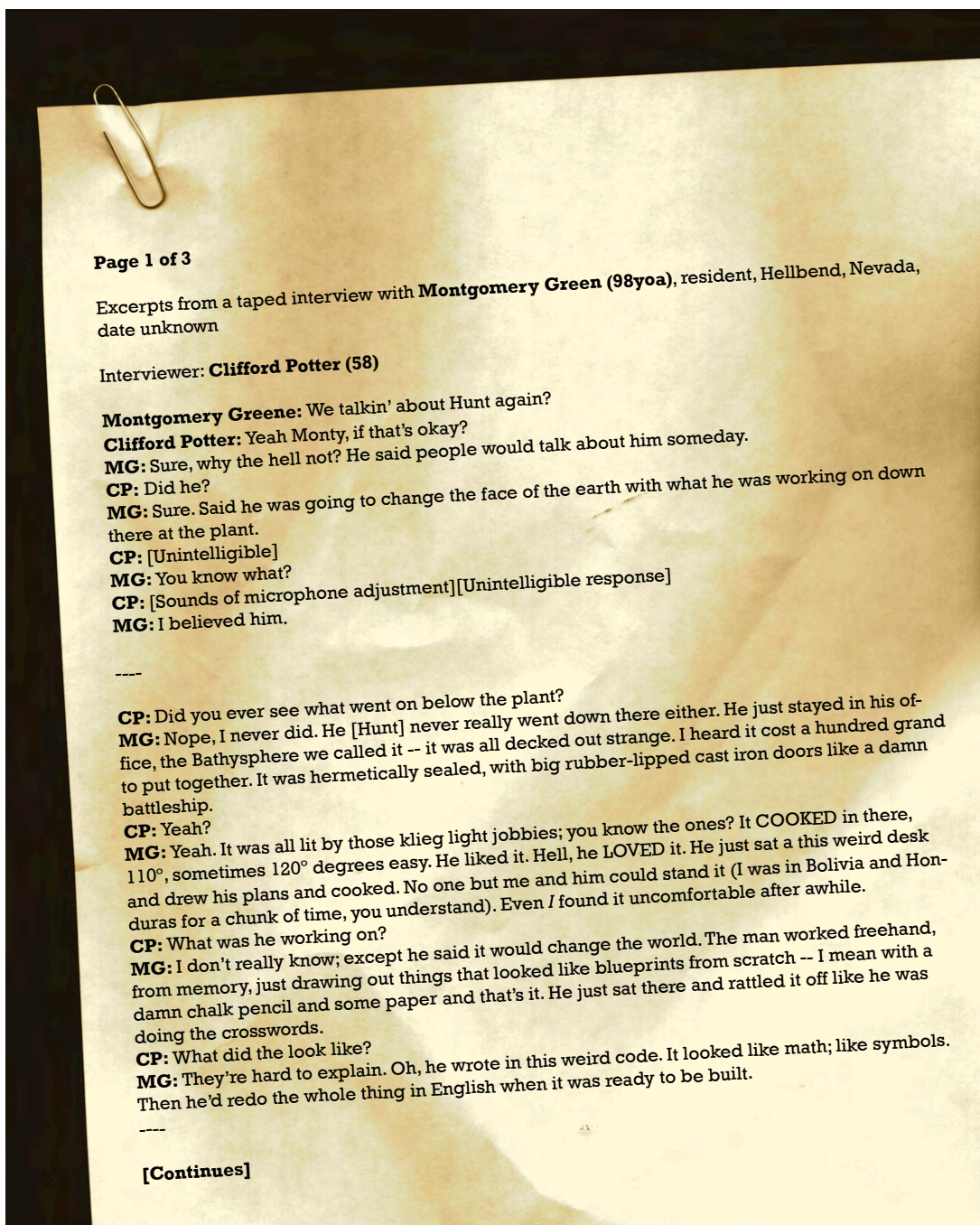

Page 2 of 3

Excerpts from a taped interview with **Montgomery Green (98yoa)**, resident, Hellbend, Nevada,  
date unknown

Interviewer: **Clifford Potter (58)**

**CP:** So you don't think English was his main language?

**MG:** I don't know. He looked white. He looked like he was from Europe or something. He seemed normal, but once or twice I heard him talk in this language...

**CP:** Can you describe it?

**MG:** Well...it sounded like some sort of South Seas lingo. Like something from New Guinea or something. I heard some in the Corps, you understand.

**CP:** Did he know you overheard him?

**MG:** Once.

**CP:** Did he ever say anything to you about it?

**MG:** Yeah, he said to forget it, he said he could speak twelve languages, that it was a gift. He could write in them too.

---

**CP:** So, his personal habits, they were strange?

**MG:** Well, if he HAD any personal habits. He never slept. I only caught him dozing once. The guy ate only vegetables. Only specially prepared stuff. It was flown in every morning by courier from Los Angeles. He'd only eat it if I washed it by hand. He KNEW when I didn't do this. I don't know how.

**CP:** So he was odd?

**MG:** Odd ain't the word. But he was a good boss. Then again, I was used to the Corps. Anything seems good after the Corps.

**CP:** So he was a good boss?

**MG:** Oh yeah.

**CP:** Do you think you could go into that a bit more?

**MG:** Sure. Don't get me wrong, he *hated* everyone. All the guys who worked for him. He never once said a kind word to anyone. Conversations with him were always about three sentences. He's ask you a question, you understand, you'd answer, and then he'd berate you. But he was always right, and he rewarded loyalty, and consistency. I had that stuff down from training. I did everything he asked, down to the letter; by that time, it was second nature.

**CP:** So you think he liked you?

**MG:** Nah, he TOLERATED me, you understand?

[Continues]

**Page 3 of 3**

Excerpts from a taped interview with **Montgomery Green (98yoa)**, resident, Hellbend, Nevada,  
date unknown

Interviewer: **Clifford Potter (58)**

**CP:** Did he ever go outside?

**MG:** Once or twice I seen. He wore these old goggles. Bakelite goggles with black-out glass when he went.

**CP:** Yeah?

**MG:** Yeah, he could see just fine in the dark. He walked around after hours sometimes in the rooms surrounding his office, in the dark.

**CP:** So, he wore them whenever he was in sunlight?

**MG:** Yeah, he liked heat, he liked the lamps, but something about the sun bugged him. Not his skin, just his eyes.

---

**CP:** So he didn't like blood? You said something about that...earlier?

**MG:** Yes. I cut myself once while preparing his lunch, and when I walked in the tub [Hunt's office] he got up and started screaming at me. He was really, really mad. Really PO'd. He stood away from me like it was catching.

**CP:** What was he yelling?

**MG:** [Laughs] For me to get out. To come back later. That he wasn't hungry. That my blood made him sick.

**CP:** So you bled a lot?

**MG:** That's the thing, I didn't bleed hardly at all, and just on a finger. The finger was wrapped in gauze.

**CP:** So he saw the bandage.

**MG:** Nah, I had my other hand with the cut on the door, he couldn't see it.

**CP:** So how did he know?

**MG:** [Laughs] I think he SMELT it.

---

**[END]**

# Stats for Future/Perfect 1

## The Players

### Special Agent Clark Grunberg Agent TAYLOR

**Race:** Caucasian, **Education:** B.A. Criminology, **Occupation:** Special Agent FBI, **Age:** 44, **Height:** 6'2", **Weight:** 199 lbs, **Hair:** Grey, **Eyes:** Green  
**STRENGTH** 15 **SIZE** 13 **CONSTITUTION** 16  
**DEXTERITY** 12 **POWER** 17 **APPEARANCE** 11  
**INTELLIGENCE** 11 **EDUCATION** 21

**HP** 16 **MP** 17  
**SANITY** 85  
**IDEA** 55% **LUCK** 85% **KNOW** 105%  
**DMG BONUS:** +1d4

**SKILLS:** Administration 31%, Biology 22%, Chemistry 36%, Climb 31%, Computer Use 55%, Credit 61%, Dodge 12%, Drive Automobile 45%, History 39%, Law 50%, Listen 46%, Occult 22%, Search 40%.  
**LANGUAGES:** English (own) 100%  
**ATTACKS:** Punch 40% (1d4+1d4)  
S&W 1076 Semi-Automatic, 44% (1d8+4)

### Special Agent Kimberly Tralvayne Agent TATE

**Race:** Caucasian, **Education:** M.A. Psychology B.A. Criminology, **Occupation:** Special Agent FBI, **Age:** 43, **Height:** 5'9", **Weight:** 181 lbs, **Hair:** Brown, **Eyes:** Blue  
**STRENGTH** 8 **SIZE** 12 **CONSTITUTION** 18  
**DEXTERITY** 16 **POWER** 15 **APPEARANCE** 8  
**INTELLIGENCE** 13 **EDUCATION** 21

**HP** 13 **MP** 15  
**SANITY** 75  
**IDEA** 55% **LUCK** 85% **KNOW** 105%  
**DMG BONUS:** 0

**SKILLS:** Accounting 21%, Administration 22%, Anthropology 41%, Chemistry 44%, Computer Use 67%, Computer Programming 22%, Cooking 22%, Dodge 35%, Drive Automobile 40%, Fast Talk 43%, Law 55%, Psychology 55%, Search 33%  
**LANGUAGES:** English (own) 100%, Latin 12%  
**ATTACKS:** Punch 40% (1d4)  
Glock .40 S&W, 51% (1d10)

### Special Agent Lewis Makamura DG Friendly

**Race:** Asian/Caucasian, **Education:** M.A. Forensics B.A. Criminology, **Occupation:** Special Agent FBI, **Age:** 38, **Height:** 5'9", **Weight:** 193 lbs, **Hair:** Black, **Eyes:** Green  
**STRENGTH** 15 **SIZE** 12 **CONSTITUTION** 17  
**DEXTERITY** 12 **POWER** 14 **APPEARANCE** 16  
**INTELLIGENCE** 14 **EDUCATION** 21

**HP** 16 **MP** 14  
**SANITY** 70  
**IDEA** 70% **LUCK** 70% **KNOW** 105%  
**DMG BONUS:** +1d4

**SKILLS:** Administration 34%, Chemistry 61%, Computer Use 71%, Dodge 22%, Drive Automobile 44%, Forensics 70%, Law 43%, Search 50%  
**LANGUAGES:** English (own) 100%, Japanese 31%  
**ATTACKS:** Punch 50% (1d4+1d4)  
Glock .40 S&W, 33% (1d10)

### Michael Grunning\* The Great Race Agent

**Race:** Caucasian, **Education:** M.A. Forensics B.A. Criminology, **Occupation:** Special Agent FBI, **Age:** 17, **Height:** 5'11", **Weight:** 188 lbs, **Hair:** Brown, **Eyes:** Blue  
**STRENGTH** 16 **SIZE** 10 **CONSTITUTION** 3  
**DEXTERITY** 5 **POWER** 18 **APPEARANCE** 14  
**INTELLIGENCE** 18 **EDUCATION** 10

**HP** 10 **MP** 18  
**SANITY** N/A  
**IDEA** 90% **LUCK** 90% **KNOW** 50%  
**DMG BONUS:** +1d4

**SKILLS:** Chemistry 61%, Computer Use 99%, Drive Automobile 20%, Electronics 81%, Temporal Physics 99%  
**LANGUAGES:** English 50%, Chinese 22%, Russian 22%  
**ATTACKS:** Lightning Gun, 53% (1d20+4)

\*These are stats for the Great Race Agent; it is immune to SANITY rending effects. Grunning however has a SAN of 90.

# Stats for Future/Perfect 1

## The Players Page 2

### Jarvis Greene Local Pot-Head

**Race:** Caucasian, **Education:** High School, some College **Occupation:** Gas Station Attendant, **Age:** 22, **Height:** 5'11", **Weight:** 201 lbs, **Hair:** Brown, **Eyes:** Brown

**STRENGTH** 16 **SIZE** 13 **CONSTITUTION** 10  
**DEXTERITY** 11 **POWER** 7 **APPEARANCE** 18  
**INTELLIGENCE** 12 **EDUCATION** 10

**HP** 13 **MP** 7

**SANITY** 35

**IDEA** 60% **LUCK** 35% **KNOW** 50%

**DMG BONUS:** +1d4

**SKILLS:** Chemistry 12%, Climb 20%, Computer Use 25%, Credit 12%, Dodge 28%, Drive Automobile 40%, Hydroponics 41%, Listen 22%.

**LANGUAGES:** English (own) 50%

**ATTACKS:** Punch 60% (1d4+1d4)

### Montgomery Greene Old as the Hills

**Race:** Caucasian, **Education:** High School **Occupation:** Gas Station Owner **Age:** 98, **Height:** 5'1", **Weight:** 101 lbs, **Hair:** Grey, **Eyes:** Brown

**STRENGTH** 7 **SIZE** 9 **CONSTITUTION** 3  
**DEXTERITY** 10 **POWER** 15 **APPEARANCE** 11  
**INTELLIGENCE** 9 **EDUCATION** 6

**HP** 5 **MP** 15

**SANITY** 75

**IDEA** 45% **LUCK** 75% **KNOW** 30%

**DMG BONUS:** +1d4

**SKILLS:** Accounting 11%, Administration 11%, Cooking 41%, Drive Automobile 33%, Fast Talk 55%, First Aid 21%, Geology 11%, Listen 34%, Mechanical Repair 42%, Navigate 50%,

**LANGUAGES:** English (own) 50%, Spanish 25%

**ATTACKS:** Punch 20% (1d4+1d4)

Rifle 55%

### Sheriff Alfred Mann Out of his Depth

**Race:** Caucasian, **Education:** B.A. Animal Husbandry **Occupation:** Sheriff **Age:** 44, **Height:** 6'2", **Weight:** 210 lbs, **Hair:** Brown, **Eyes:** Blue

**STRENGTH** 15 **SIZE** 18 **CONSTITUTION** 11  
**DEXTERITY** 12 **POWER** 10 **APPEARANCE** 5  
**INTELLIGENCE** 16 **EDUCATION** 17

**HP** 13 **MP** 10

**SANITY** 50

**IDEA** 80% **LUCK** 50% **KNOW** 85%

**DMG BONUS:** 0

**SKILLS:** Administration 51%, Animal Husbandry 22%, Computer Use 22%, Dodge 41%, Drive Automobile 60%, Law 23%, Search 65%, Veterinarian 40%, Zoology 13%

**LANGUAGES:** English (own) 85%

**ATTACKS:** Punch 66% (1d4)

.45 Colt Automatic, 71% (1d10+2)

Mossberg Shotgun, 70% (3d6+2)

### Deputy Sheriff Lucas Androzy Too Big for his Britches

**Race:** Caucasian, **Education:** B.A. Ethics **Occupation:** Deputy Sheriff **Age:** 26, **Height:** 5'10", **Weight:** 191 lbs, **Hair:** Blonde, **Eyes:** Green

**STRENGTH** 11 **SIZE** 15 **CONSTITUTION** 15  
**DEXTERITY** 9 **POWER** 15 **APPEARANCE** 5  
**INTELLIGENCE** 17 **EDUCATION** 18

**HP** 13 **MP** 15

**SANITY** 75

**IDEA** 85% **LUCK** 75% **KNOW** 90%

**DMG BONUS:** +1d4

**SKILLS:** Administration 19%, Art 9%, Computer Use 40%, Drive Automobile 33%, Photography 40%, Ride 30%, Search 39%, Sneak 33%, Track 31%

**LANGUAGES:** English 90%

**ATTACKS:** .45 Colt Automatic, 44% (1d10+2)

# Stats for Future/Perfect 1

## The Players 3

### The Killer A Rogue from the Jurassic

**Description:** Monolophosaurus **Length:** 15'5",  
**Weight:** .60 tons  
**STRENGTH** 25 **SIZE** 21 **CONSTITUTION** 20  
**DEXTERITY** 13 **POWER** 5 **APPEARANCE** 1  
**INTELLIGENCE** 5

**HP** 20  
**ARMOR** 3 (-3 HPs from every incoming attack)  
**DMG BONUS:** +1d8  
**SANITY:** 0/1d6

**SKILLS:** Ambush 35%, Hide 59%, Run 44%,  
Search 61%, Track 41%

**ATTACKS:** Claw 65% (1d8+1d8)  
Kick 45% (1d10+1d8)  
Bite 55% (1d10+4+1d8)

**TACTICS:** The Monolophosaurus is not a direct hunter — instead, it stalks its prey for extended periods, or takes targets by surprise.

It only hunts at night, and will attack anything smaller than a car. During the day it holes up in one of the many caves found in the Death Valley area.

It is no foolish animal, it is an advanced predator on the par of a wolf, and should be treated as wily, clever and exceptionally skilled at both hunting, and avoiding detection.





# DELTA GREEN FUTURE/PERFECT 2

DELTA GREEN: FUTURE PERFECT 2

## Part 2 of a Delta Green Campaign

*Wherein a darkness slips in to fill the empty spaces*

ALL TEXT IN THIS PDF IS ©2006 DENNIS DETWILLER. DELTA GREEN AND ALL RELATED CHARACTERS ARE ©2005 THE DELTA GREEN PARTNERSHIP. THIS IS A FREE, NOT FOR PROFIT PDF. THIS PDF MAY BE PRINTED AND BOUND FOR PERSONAL USE ONLY.

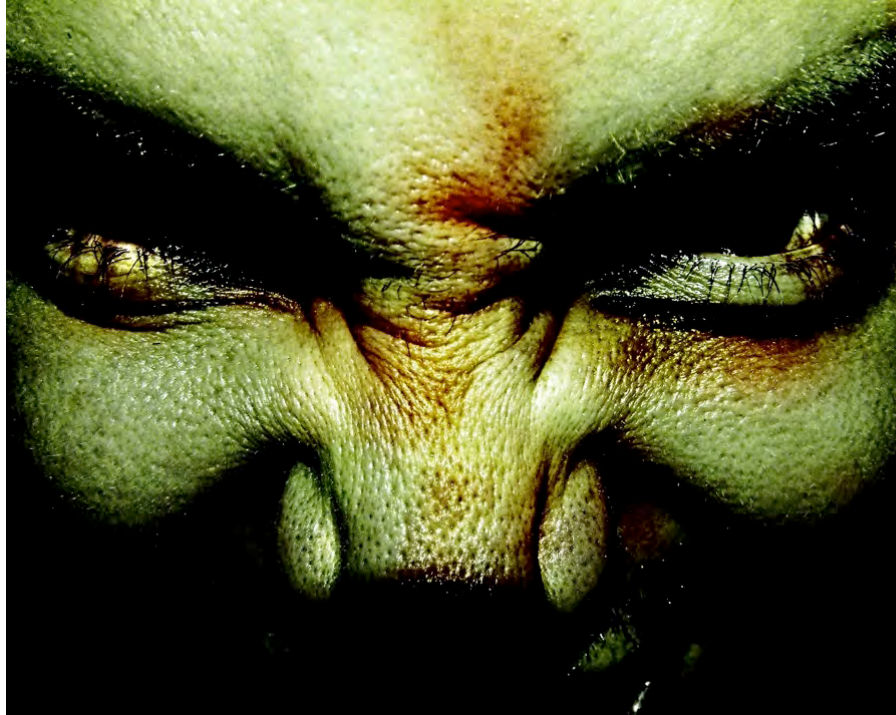

## FUTURE/PERFECT PART 2 CHESTER, OHIO

By Dennis Detwiler

### Welcome to Chester, Ohio, Home of the Mound Living in the Shadow of History

Chester is a sleepy little town in Meigs County, Ohio. It's home to the Parsons Plastics factory – the major employer in the town, and several smaller manufacturing plants. The economic dips that have come and gone since the Great Depression have somehow passed Chester by, and people like it that way.

The 20,000 people who call Chester home love it; its small town flavor has not been marred by the modern bustle of city life.

Life goes on there much in the same way as it has for the last seven decades.

It's also home to the mound. Ohio has long been known for the Great Serpent Mound; an earthwork thought to have been created almost 3000 years ago; it's the largest earthwork in the world. Chester is about 118 miles from that, but it has a mound of its own, as do several other smaller towns in Ohio.

The Chester mound draws tourists, and add a lot of local flavor. It's a series of interlocked earthworks totaling nearly 650 feet in length; also supposedly built by the Adena. From the air, it's clearly visible – three snakes pointing inward, tongue-to-tongue, undulating out in a bizarre triskelion. This symbol is everywhere in Chester, from the town seal to the local Baseball team the Chester Serpents.

The people love their mound.

But that's not all Chester can lay claim to. Over the decades it's produced some exceptional people in the shadow of that mound. It's most famous son, Arthur Hunt, the town drunk turned eccentric genius, who forged an empire on consumer electronics was born there, and a statue dedicated to him sits in the middle of town.

A 12' Hunt cast in bronze beckons to the west, his hand outstretched.

With an uncharacteristic smile on his face, Hunt's eyes point towards the mound.

In recent years, several odd crimes have marred the town's beloved mounds. Douglas Yale, the deceased Ohio River Killer who murdered and ate his victims, was connected to a series of vandalism that cut into the priceless construction, and the local coven of nuts – the New Star Crusade are often busted for trespassing at there at odd hours.

The mounds seem to draw people in.

## Chester History

### A Culture of Complacency

In 1908, Malcolm Chester, a mason from Chicago, quit his job and formed an artists' community located at his grandfather's farm — which he inherited — in the center of what is today, modern day Chester, Ohio.

Malcolm was convinced that such a community would flourish in the valley, which he fell in love with as a child. He spent four summers there in his youth, and his grandfather took him to visit the local Serpent Mounds in the 1880's. Unfortunately, sculpture and pottery—Malcolm's principle obsession—proved to be a poor fit for the valley.

For three summers, the community waxed and waned, and eventually, other small households and shops set up in the area; slowly buying land from Chester from his grandfather's vast holdings. Even as the artist community failed, a town sprung up around the Chester farmhouse. In 1912, as Malcolm Chester became the center of the growing community in the area, the Crescent Machine Company approached him to purchase a large lot of land to the northwest of the farm, with access to an offshoot of the Meigs River. In this, Malcolm Chester saw his chance.

He sold the land for a low sum, and in exchange, the company assisted in incorporating the town in 1915 as Chester Ohio. With their help, over the next twenty years, it was built up into a small but

## Connecting Part 1 to Part 2

Agents with a taste for adventure will not be hard-pressed to begin looking into the past of Arthur Hunt; particularly if they've uncovered his "oddities" in Part 1. Chester Ohio is a natural place to start pulling apart the secrets that cover Hunt's life like a shroud.

If not, A-Cell is the way to go. If the Agents failed to gain the testimony of Monty Greene (see page 27), this can be presented to them on audio tapes, and A-Cell can make noises about locating and removing any further threats that have to do with "Hunt's" past. Hunt is no longer considered a threat, but it's well known that often these "infestations" tend to corrupt entire towns.

And the town of Chester is not without obvious oddities, such as the Serpent Mound and the triskelion that seem to be a focus of local culture.

Delta Green has not forgotten its origin – the horrors of Innsmouth – an entire town devoted to the worship of the Great Old Ones. That such a horrific and dangerous threat could go overlooked for decades in the center of the country has occurred to the leaders of A-Cell.

The only thing worse than another Innsmouth to Delta Green is an Innsmouth that goes undiscovered until it is too late.

## Starting with Part 2

If your players are entering the investigation through Part 2, there are some simple shifts in focus that will both allow them to begin in Chester, Ohio, and find the threads necessary to find their way to Hellbend and Duxbury Pennsylvania.

In this case, focus of the investigation should be the New Star Crusade and his connection to the Ohio River Killer (see page 38). The players can be drawn into the mystery of Arthur Hunt, and from there, on to Hellbend Part 1 and Duxbury Part 3.

## The Skinny

Nothing, really, is wrong with the town of Chester, Ohio itself. There are supernatural anomalies (such as the mounds, the Ohio River Killer and Arthur Hunt himself) but the town is surprisingly normal otherwise.

Its obsession with its Snake Mounds and the triskelion snake image is just a natural bit of town pride. It has no supernatural significance – it's just as like putting the Statue of Liberty on a New York t-shirt, or the Eiffel Tower on a souvenir from Paris.

But the players don't NEED to know this. As far as they are concerned, the town can seem sinister and just "a little TOO nice". In fact, playing up this apparent veneer of good will can be a great way to enhance the paranoia. And paranoia is what Delta Green is all about.

bustling, modern town.

In 1923, in an incredible transformation, a local drunk—Arthur Hunt—suddenly became the town’s resident genius. Drawing reporters from all over the state, Hunt went on to form Hunt Electrodynamics in Chester; patent sixty significant electronic inventions and then leave the town; all in a matter of four years.

But Hunt left a large Hunt Electrodynamics plant behind, which rapidly supplanted the waning fortunes of the Crescent Machine Company as the number one employer in town.

By 1943, with the death of Malcolm Chester, a new company arrived in town through the workings of Hunt Electrodynamics – Parsons Bakelite Company; a plastics manufacturer for the war effort.

This small business exploded over the next two years of the war.

When the Hunt plant closed in 1953 during the restructure of Hunt Electrodynamics following the death of Arthur Hunt; the Parsons Company expanded their holdings, and became the town’s chief employer. Renamed Parsons Plastics, they have remained the #1 employer in Chester for the past fifty years, producing light sockets, plastic tubing, and cheap plastic screws.

Since the late 1950’s, Chester has slowly expanded to incorporate several smaller towns that surrounded it. In 1961, the city of Chester was incorporated by the state, and became the third largest city in Meigs County.

Chester, Ohio	Facts
Area	9.52 Miles
Population	12,950 (1950 Census), 20,982 (2000 Census)
Founded	1915
Industry	Plastics, Tourism
Temperature	High: 104 F (40 C), Low: -109 F (-78 C)

## The Hunt Museum A Tribute to a Recluse

Following his sudden and cryptic death in 1952, the town constructed a museum to celebrate Arthur Hunt, its most famous and prodigal son. The building sits in the center of town – a nine room, two story stone structure, fronted by a small park with a statue of Hunt in its center beckoning to the west. People often use the park (it’s official name is “Malcolm Chester Park”, but is most often called “Hunt Park”) but rarely visit the museum.

This building is maintained by the town, and is open for free to the public, but is almost always empty. It contains displays unchanged since 1952, documenting Hunt’s bizarre life, and showing the first Hunt Mark 1 Resistor – a device that revolutionized consumer electronics. Up until the summer of 1990 it employed two fulltime personnel, now it only employs one part time; with the majority of the bills supported by the township and Parsons Plastics.

For more information on the Hunt Museum, see page 51.

## The Adena The Mysterious Mound-Builders

The Adena Mound Builder culture, which rose and fell in the United States long before the first Europeans arrived in North America, has left behind a legacy of earthworks and ancient mound structures from as far East as West Virginia, all the way to the edge of Oklahoma. They are thought to be responsible for the construction of the Great Serpent Mound and Chester’s more modest Triskelion of Serpents.

Little is known of these people, and it remains a matter of archaeological debate whether or not a single culture was responsible for the various earthwork structures found in random portions of the eastern half of the U.S.

The surviving local Native American population of Shawnee Indians have their own theories about the Mound Builders – they tell stories of a time when the Shawnee encountered “strange white-faced people” who lived “in” the mounds.

These people, who feared the sun, worshipped Maneto (“The Snake”) and after the hunting in the area soured, the Shawnee made war on them and forced them from the mounds. The beings fled west or died defending their mounds.

More specifically, there is a legend about the Chester Mound itself. It is said that when the Shawnee made war on the strange people, their last shaman “drew down a star” and smashed the earth with it in revenge, killing himself, a Shawnee chief and his wives. At the point of impact, the Shawnee built the three-Maneto mound; snakes turned in upon themselves, to prevent their spirit from escaping and haunting the Shawnee.

Despite a recent craze in recording Indian verbal Native American traditions, few put credence in such legends; although a local geographic survey of the Chester Mound placed it on cryptoexplosion structure – a place that it is highly likely was subjected to a meteor impact sometime in the past.

For more information about the Chester Mound, see page 48.

### The New Star Crusade Local Nut-Cases

When Michael Brown quit his job as a professor at the Ohio University in 1985 and settled in Chester, Ohio at his family farm, little was thought of it. But when it was discovered that he was assembling an “army” of believers on his property and arming them, local authorities became interested. There was nothing they could do, of course, until Brown did something first.

Brown—who changed his name to Danen Ignis—formed the New Star Crusade officially in 1987 after the death of his elderly father. By 1988 his newsletter, Crusade had 3,800 subscribers and by 1995, with the advent of the Internet, that number had doubled. Lost and troubled souls were drawn to the Brown farm from as far a field as Stockholm, Sweden and Osaka, Japan. They freely gave their personal fortunes up for a chance at redemption. Ignis’ influence grew with his wealth, and by the 1990’s he was a multimillionaire.

Ignis claimed his group was a revival of the culture that worshipped at the Chester, Mounds in ancient times. He was certain that if they prayed and made offerings at the mound, a new star would descend and take them from the Earth to another, more pure, world. But there would be conflict – forces would attempt to stop them. They needed to be ready.

They fought four court battles to be permitted to perform rites at the Chester Mounds on the solstices, and after a final, pitched battle that fell just short of the Ohio Court of Appeals; they were permitted to

do so. For several years, the “nuts”—as the locals referred to them—continued their rites in peace. Until Douglas Yale, the infamous Ohio River Killer joined their group.

After the Ohio River Killer debacle, the New Star Crusade went underground, no longer appearing in public, and Ignis; now in his fifties, has not emerged from the property in some time. The solstice rites continue however, undeterred but carefully watched by local authorities.

For more on the New Star Crusade, see page 44.

### The Ohio River Killer Douglas Yale

In 1997, a plain individual with a long history of psychological problems, Douglas Yale joined the New Star Crusade. At first, there was little special about Yale; he faded into the group, sticking close to Danen Ignis and doing whatever was asked of him. But soon, Yale began causing trouble in town, something the group tended to avoid. Yale was arrested twice for drunk and disorderly conduct, and once for assault. When Ignis confined him to the farm, he turned his problems on the Crusade.

In 1998, after an armed confrontation, Yale was ejected from the New Star Crusade Farm. For six months, he vanished, but was seen from time to time in town. Rumors persisted that he was living in the forest in an old tent. He was known to frequent the mounds at night; and on October 21, 1999 was discovered defacing the mounds by a deputy.

Yale “in a rage” seriously injured the deputy, who only survived by shooting Yale five times with his sidearm. Still, Yale escaped. One of the largest manhunts in Ohio history followed.

For the next seven months, through one of the worst winters in Ohio history, Yale eluded capture. In that time, three people disappeared. When their bones—picked clean of flesh—were found, Yale became the sole suspect.

In the summer of 2000, Yale was captured at the Chester Mound on the Summer Solstice after local authorities watching the New Star Crusade rites saw him at the edge of the forest. Despite enduring a hail of bullets, Yale survived unharmed. He was catatonic and unresponsive while detained, and was thrown in the Chester lockup.

After a day and a half in custody, Yale vanished from his cell on the night of June 23, 2000 along

with Sheriff's Deputy Arthur Falstaf – an officer with a distinguished career. It was strongly suspected that Yale had an accomplice of some sort, and that it was likely Falstaf was dead. Under tight surveillance for weeks, the New Star Crusade was hunkered down at the Ignis farm, and was quickly eliminated as a suspect.

Over the next month an a half, four more people disappeared, their bones found by hunters, hikers and travelers in the back woods of the county. The bones had been gnawed clean of meat. In this time Yale became famous as the Ohio River Killer on the national news. Comparisons to the likes of Ted

Bundy and Son of Sam were made and dozens of reporters descended on Chester to cover the story.

In October 2001, the case took an even stranger turn. A set of bones found by hikers near the Chester Mounds were identified as those of Douglas Yale – there was no mistake – the man thought to be responsible for seven confirmed and one suspected death was dead. They too, were gnawed clean.

In death, Douglas Yale remained as much of a mystery as in life.

For more info on Yale, see page 56.

### What's Really Going On

The Chester Mound is home to the sleeping bodies of twenty-six "Degenerate" Serpent Folk, those who thirty centuries before served the Serpent Man that would take the form of Arthur Hunt. "Hunt" chose to leave them in their slumber until such a time as they would be beneficial to his cause. They are crude, violent creatures, capable of only physical labor and a blunt, hypnotic mind-control. In the past they were his loyal guards and laborers, but in the modern they were of little use – in fact, in a world overrun by mammals, their presence would pose a huge threat to "Hunt's" plans.

When "Hunt" was roused, the wards lifted woke one of the lesser creatures as well. This creature – still trapped within the mound – could only reach out with its primitive mental abilities to those nearby. This power affected the mentally ill more profoundly than others; though nearly anyone who went near the mounds could "feel" something. Slowly, as this creature drew power from those it had "affected" it began to exert more influence and control. First it drew in Chip Brown, and then Michael Brown – but it lacked the power to force their hand to release it from its tomb.

The dreams it sent to Michael Brown shaped his mental illness into the New Star Crusade cult, which in turn drew followers that fueled the creature further. It was building a charge like a battery – power it would use to affect its escape.

Douglas Yale was the key. By the time he appeared, the creature had grown bloated on the power it fed on from the New Star Crusade worshippers, and it began to reshape the already flawed mind of Yale to its motivations. This turned Yale against the Crusade and the townsfolk, and almost derailed the creature's plans.

Finally, after his ejection from the cult, the creature exerted enough influence over Yale to dig it free of the mound. It consumed and became Yale. Weakened, but finally free, it confronted by Deputy Jason Kisent, who believed he had discovered the deranged Yale defacing a local monument. Kisent was lucky to survive the encounter.

The creature lived in the woods of Meigs country, feeding from time to time on people who had the unfortunate luck of crossing its path. It would secretly return to the mounds on the summer solstice to "feed" on the worshippers, replenishing its reservoir of "power" with which it could manipulate minds.

For the most part, the subtleties of human culture were lost on it; and it cared little of the developments of the world since its entombment thirty centuries before. Masterless, it had no motivation save survival and satiation.

When the creature was discovered near the mounds on the night of the summer solstice June 21, 2000, it was nearly drained of all its power by a devastating hail of gunfire from more than a dozen officers. The hunt lasted more than two hours, and ended with the creature, still in the guise of Douglas Yale, in the county lock-up.

The creature soon worked its powers on Deputy Arthur Falstaf; controlling the unfortunate soul and consuming then becoming him. It escaped and slowly but surely continued its killings, in the hinterlands of the county, this time in the guise of Falstaf and others.

The conventional case against Yale died in October 2001, when Yale's bones (long gnawed clean by the creature) were discovered near the Chester Mounds. The creature still wanders the back woods of Meigs County, utilizing its human disguises as a natural camouflage to draw unsuspecting travelers in.

# Getting Started

## DG and Chester, Ohio



### Getting the Agents to Town Point of Entry

Agents who have survived the terrors of Part 1 will no doubt hope to discover just what is going on with Arthur Hunt. There are several ways to get Agents into town.

### Vacation, Sick Leave, Family Problems... DG's Mantra

Agents with Federal Law enforcement will have a hard (if not impossible) time getting assigned to a case outside of their area; the classic Delta Green solution is vacation, sick leave or the old standby: family problems.

Only specialists with a narrow application in the field (such as a cryptanalyst or a forensic facial reconstructionist) or those in a Federal role that allows a wide berth of investigation (homeland security, USAMRIID, CDC) have the chance of being assigned to a case far out of their usual area of jurisdiction. If this is possible, A-Cell will make it happen, if not, it's back to the old standbys.

The mantra of vacation, sick leave and family problems should be second nature to experienced Delta Green Agents. Those new to the cause may need some coaching in this area.

The best call is vacation – you duck out and make your way across country (or whatever) and pretend to be assigned to a case. Vacation is pretty much foolproof as long as you're not discovered flashing a badge 2,500 miles from your jurisdiction.

Sick leave is a bit more dangerous, and tends to draw the attention of co-workers. Someone might drop by your place; ring you up to see if you need anything, etc... If you're not there (and say, your mail is piling up at your door), you could be in trouble when you get back.

Family problems (like a death in the family or illness) are good, but again, can lead to problems. Sympathy bouquets, questions about the location, state of the sick loved one; keeping these stories straight can be troublesome.

### No Cover, On Their Own One Step From Suspension

This is the simplest way in – no strings are pulled, no local law enforcement is notified and the Agents are basically on their own. They only have A-Cell to look to when things go wrong, and no local cooperation can be expected.

In fact, it's likely that since most DG Ops involve criminal activities, one or more of the Agents might be detained, arrested or even convicted by local law enforcement. This is a dangerous, though somewhat less restricting method for investigating Chester.

### A-Cell Pulls Some Strings It Pays to Know People

This option should require some sort of role-playing on the part of the Agents. In this scenario, A-Cell pulls some strings to get the Agents “officially” sent to Chester. This should be requested of A-Cell, and should be a hard sell, since it puts more Agents at risk than just the PCs. As is stated above, this should only be possible for Agents with a particular (and rare) specialist; but this does not mean that these “assigned” Agents can bring in others and personally vouch for them.

In this option, after some finagling, the Agents can be assigned one of many different tasks, the most obvious of which is compiling a case profile on the Ohio River Killer. With this kind of access, with everything on the up and up, the Agents can expect copious local cooperation as well as cooperation from local Federal Authorities in Cincinnati.



## Room and Board Location, Location, Location

Chester, Ohio is located 194 miles from Cincinnati airport, and is dotted with several small, out of the way hotels and motels (see the map of page 61 for more details)

The Agent's best bet lies with the anonymous motels that dot Highway 50 to the northeast of town -- they are technically out of the jurisdiction of Chester, Ohio, and are home only to traveling businessmen and tourists. In other words, people who mind their own business.

Staying in town at the Regency Motel or one of four bed and breakfasts is a much more high profile (and therefore more dangerous) proposition.

If the Agents stay in town and are implicated in some type of crime, numerous witnesses will step forward reporting their schedule in detail to the police department, making it much more likely that such charges will stick.

In such a town, there is little else to do except talk about strangers. If the Agents are public about their "investigation" this will draw even more scrutiny.

Staying in town also makes it far more likely that the local police department will take an interest; at least after some sort of crime seems to have been committed.

## The Cincinnati Cell F-Cell

F-Cell is a skeleton crew, decimated by an Op gone wrong. Early in the year an occult-connected man named Zacharias Wilkes killed two (of four) Agents in the cell.

The two remaining Agents (one local Policeman and a DEA Agent) are very paranoid about their involvement in the Op, and have made it a policy to meet only when vitally necessary. They operate in the Cincinnati area, but for the last half-year they have looked into A-Cell requests independent of one another to prevent any investigation of conspiracy.

DEA Agent Rigoberto R. Young and Police Sergeant Stephen Moreno represent all that's left of F Cell, and they're not exactly knocking down doors to get back into the action.

If summoned by A-Cell to meet with the player

characters, they will choose an out-of-the-way spot, like an isolated highway overpass; an abandoned rail yard or a dilapidated farm; perfect ambush territory. They will assist in whatever way the Agents need -- though they'll seem reticent and evasive.

Stephen Moreno, particularly, is on edge; though he appears well adjusted and normal, though cautious. He has been wracked with severe nightmares since the shootout that ended the lives of his cellmates. Any significant supernatural threat directly encountered by Moreno (over 2 SANITY points suffered) transforms him into an animal. Moreno will unload his weapon at the source of his fear (or anyone who tries to restrain him), and then lapse into a catatonic state from which he'll never rise.

Young, on the other hand, is made of (mostly) sterner stuff, and though he doesn't wish to be involved, he'll do his duty to the best of his ability. However, Young requires alcohol. Without it, he becomes unfocused, jumpy and liable to make mistakes. If involved in a violent situation without some alcohol to "give him a leg up" Young is liable to shoot a player character by accident (the Agent with the lowest LUCK roll needs to roll; on a fail, they are hit by Young's accidental gunshot and suffer 1d10+2 HPs damage).

This is not to say that they're useless. Agent Young has access to Federal information on the New Star Crusade and Danen Ignis, as well as access to in-





formation on Douglas Yale. Sergeant Moreno can access the State Police database, and call up nearly any crime in Meigs County in the last forty years.

### The Green Box Green Box #419

Green Box #419 is located 2 miles outside of Cincinnati (194 miles from Chester), in the Park-N-Store-It. It's a 20x20' corrugated steel box with a steel rolling-top door. The door is pad-locked with a rusted Yale lock.

The current members of F-Cell have not visited it – they don't even know it exists.

The Park-N-Store-It is surrounded by a 12" razor-wired top fence, and is accessible during business hours only (8 to 5). The key to the unit is hidden on top of the lip of the door, amidst moss, rotting leaves and water. It is obvious it has not been used in years.

Inside, the unit is packed with what seems to be the remnants of an estate – old looking tables, chairs and a disassembled bed, all wrapped in plastic and covered in dust. Two paintings, each bound carefully in yellowed muslin bound with wire are stowed in the corner up on milk crates to keep them from the wet floor. Besides this, there is little else of interest.

Many of the items are marked in fading pen with the following inscription "Pickman-Wright Estate 01/12/69".

Those opening either of the two paintings are in for an upsetting turn of events.

### Painting 1: The Tower

This painting of an ancient stone tower with staggered windows is haunting in its simplicity. The painting is signed "R.U.P."



Anyone staring at it at length finds themselves drawn to the birds circling the tower. Those failing a SANITY roll find they can hear the birds – crows – as the wheel in the sky, and they will continue to stare until they are pulled away. Those left watching the painting for more than 10 minutes will begin to see it move (0/-1 SANITY).

Those unfortunate enough to come upon the painting alone and who fail a second SANITY roll are not seen again. They will be observed going into the unit by the manager, and the painting will be unwrapped and pointed at a set of footprints in the wet, dirty, ground, but besides that, they will seem to have vanished from the face of the Earth.

This painting has a second, more effective use; one that A-Cell would be most interested in – items smaller than a person left facing the uncovered painting for more than 10 minutes vanish, never to be seen again. This method can permanently remove nearly any piece of evidence to a place where it is quite literally, beyond human reach.

### Painting 2: The Bride

This unfinished painting of a pale woman clad in crimson seems to catch the light in amazing ways, making it difficult not to observe at length (make a LUCK roll or look more closely). Those staring at it are drawn to the woman's lips, which are painted black.

Those failing a SANITY roll lose 1 SAN point and seem to see the lips move; and the whisper of the word "Kadath". The painting does nothing else. The painting is un-signed.



## The Adena An Ancient Culture



The Adena mound builder culture is a mystery, and it's unclear if they were a single tribe or a mixture of tribes with similar rites and rituals. Archaeologists cannot seem to agree on anything about the Adena except the following:

What is known is that the earthworks they constructed pepper the United States from the edge of Oklahoma to West Virginia and date between 2,000 BC to about 100 BC.

These earthworks are some of the largest in the world, and some (such as the Chester Mounds and the Great Serpent Mound) are intricate and detailed.

They are thought to be the predecessors to the modern Indian tribes that populated the area when Europeans began populating the continent. Many Indian tribes claim to be unbroken descendants of the culture; but no one has definitive proof.

### The Last Age of the Serpent Men

In actuality, the early Adena culture represents a series of human "fiefdoms" ruled by singularly powerful Serpent Men nearly 3,000 years ago. These few Serpent Men (numbering less than a half dozen) ruled vast areas of the North American continent by enslaving and terrorizing the human culture they found there.

The first Serpent Man to wake from a 3 million year slumber found the kingdom it had left behind wiped from the surface of the Earth. He resurrected an army of Degenerate Serpent Folk, and woke other more powerful Serpent Men, those who had survived the downfall of their culture 750,000 years before. He hoped to forge a new Serpent Man culture in the wilds of the mammal-overrun world.

Unfortunately, the Serpent Men are a secretive and reclusive race. Soon disputes erupted in war between the leadership. Each created a small kingdom, using their magics to enslave the primitive cultures and made war on each other. This war lasted nearly 1,000 years.

This pointless conflict ended with the human culture discovering the Serpent Men's weakness. There was a reason the Serpent Men were strict vegetarians, their bloodlust was so great that once tempted by blood, they would feed until glutted and then enter a torpor in which they were eminently vulnerable.

This quickly led to the death of many powerful Serpent Men, bringing an end to the brief Last Age of the Serpent Men. However, one, Xichlasa – the creature that would become Hunt – reentered his slumber, protected by a force of Degenerate Serpent Folk. His twenty-five most valued guards were buried with him.

These Degenerate Serpent Folk remained in the area until the Shawnee Indians appeared nearly 2,500 years later. By that time, the Degenerate Serpent Folk could not offer significant resistance to the organized, resourceful and spiritually powerful Shawnee, who killed and drove off the creatures.

Sensing its evil, the Shawnee "quarantined" the Chester Mound. Those few drawn to its power were slain and Shawnee warriors patrolled it often, to watch for signs of the "strange white-faced people's" return (the Degenerate Serpent Folk). Meanwhile, embedded in the Chester Mound, Xichlasa slept, waiting for a time more suited for his kind.

He slept there for nearly 3,000 years, until the local drunk Arthur Hunt dug him up in 1923, and he was let loose on the modern world in the guise of rescuer.

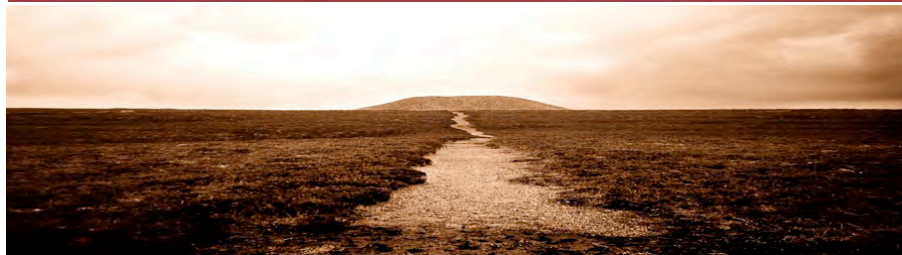

## John Maskenogi Local Shawnee Writer

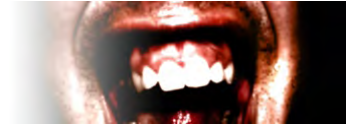

John Maskenogi is a ½ Shawnee Indian and local writer who has made a comfortable living writing about the Shawnee culture. Maskenogi has released several speculative books about the mounds and their relation to Shawnee legend, often exaggerating supernatural concepts to drum up sales. In person, he comes across as a learned, quite serious scholar of Indian occult lore, but actually, this is mostly a charade. Since he stumbled on this source of money, he has cultivated the airs of a true believer, but it actually, he thinks it's all hogwash.

He is a local Chester celebrity, and is considered the expert on the Adena Mounds. He knows all the most popular Shawnee stories (including the “moon-faced people” who were driven off from the mound) and often gives speeches at the local colleges and bookstores on the subject.

Maskenogi is a natural contact to develop in the area, and will act as a researcher for those who seem to be in authority in any case involving the mounds – however, he will exploit this involvement to spin-off a new book filled with information about the case that is best left unreported (particularly if the Agents are on vacation and using their real names).

Of course, he'll keep this “idea” to himself until the Agents are long gone, and only publish after-the-fact, though observant Agents will be paranoid about having an exploitative writer along on some of their investigation. Careful Agents may find out about his plans by poking around Maskenogi's house or vehicle, or through other, more violent means.

### Maskenogi's Writings Drifting into Fiction

Maskenogi has written four books on the Mound Builders and Shawnee, drawing parallels between the cultures and implying, in no small terms that one culture became the other. As his books developed a following, they have rapidly taken a turn from straight works of history to something bordering on sensationalism.

#### The Mound Builder Mystery (1997)

This largely academic title postulates a connection between the Adena and Shawnee cultures, using verbal traditions, comparisons of wood and stone

craft and other conventional forms of Archaeology.

Of Maskenogi's books, this is the most academic.

#### Shawnee Legend and the Snake Mounds of Ohio (1999)

This title is an interesting weave of verbal tradition, songs and other Shawnee legends about the mounds. It paints an interesting picture of the Shawnee's relationship with the mounds – and does much to contradict Maskenogi's first book.

Far from implying the Shawnee were of the Adena culture, it indicates the Shawnee arrived to find another race of “moon-faced people” occupying the mounds, and after several large skirmishes, finally drove them off. This title was a surprise hit, selling 10,000 copies worldwide and placing Maskenogi on a short list of scholars on the subject of the Mounds.

#### Maneto: The Snake God (2002)

This slightly more sensationalistic title examines a particular Shawnee tale related by John T. Walker, a full-blooded Shawnee in his 90's. The story is of the Chester Mounds and their relationship as a site for worship of Maneto, the snake god.

Walker (now dead) paints a picture of the site as either a site of worship built by the “moon-faced people” to their god Maneto, the snake, or as a “spirit trap” built by the Shawnee after the people were driven off. Walker's stories are fascinating, often contradictory, and quite involved. Due partly to a new book deal, this book sold twice as much as Maskenogi's previous title.

#### In the Shadows of the Mounds (2003)

This title is by far Maskenogi's least academic – it is obviously full of unsupported suppositions, hearsay and just plain sensationalistic lies. It is an uneasy mix of his former work and straight fiction involving the Douglas Yale murders, the New Star Crusade and other oddities of the mounds.

Still, it was a successful title, breaking his sales record by more than 5,000 copies, driven mostly by interest in the Ohio River Killer.

## The New Star Crusade A Glimpse of Darkness



The New Star Crusade is a small cult dedicated to the following principles:

1. *That Danen Ignis (Michael Brown) is the reincarnation of the one who constructed the mounds millennia ago*
2. *That those who accept Ignis as their leader are imbued with the spirit of the people who helped build the mounds*
3. *They believe that through worship at the mounds they will call down "others" and these others will take them to a new world*

Its membership worldwide is about 8,000, though most are not far enough down the road of delusion fully embrace their mythology. Those who have dedicated themselves to the cult (who number less than fifty, all told) have pledged all their earthly possessions as well as their body to Danen Ignis.

The cult is not a recognized religion, but is fastidious in all matters legal and financial. Ignis is a stickler for playing the system, and does not take unnecessary risks. His personal wealth is somewhere in the realm of the tens of millions of dollars – all gained from devoted followers, and he does not risk it recklessly.

Those in town, particularly the police, know very well that although Ignis may be insane, he is methodical, and is very adept at exploiting the legal system. Early attempts at legal wrangling cost the county nearly a million dollars, and the local city

government has a very clear "hands off" policy against the cult. This, however, backfired as well.

Back before Douglas Yale, trespassing by townies was a common thing on the farm, and the local authorities refused to act with "necessary speed and clarity" to resolve such situations. Ignis taped the phone calls to the local Police, and recorded their arrival times (the shortest was over 2 hours). He then filed a personal suit against the county and cost them another 800,000 in damages.

When the state of Ohio tried to intervene and block the cult from using the mounds for worship, Ignis spent nearly 3 million dollars on legal fees, taking the fight to one step below the Ohio Court of Appeals. He won the battle handily on the concept of freedom of religion. He also made national news and drew in new followers.

Soon the town of Chester found itself answering to Ignis, and few could see any way out of the situation. The police monitored the farm, but could do little else. Ignis paid his taxes and bills on time, and spent copious amounts of money in town.

Even when the Douglas Yale situation burst upon the scene in 1999, no one in Chester even dared attempt some sort of accusation or suit against Ignis. By that time, everyone in city government knew it was a losing battle. And the cult's lawyer in Cincinnati, Richard A. Goldfarb, sent a strongly worded letter to the police department warning them against making a public connection between Yale and the Cult.

No one did. Since the resolution of the Yale incident in 2001, the cult has remained quietly behind the scenes. Performing its rites in isolation away from the town. The town likes it that way. They've learned to leave well enough alone.

### Danen Ignis (Real Name Michael Brown)

Michael Brown was an professor of Literature at the Ohio University for 12 years before he packed up and left it all behind to return to his family farm. Most at the University believed he was on his way home to care for his ailing elderly father. The formerly talkative and social Brown had changed over a period of months into a somber, distracted indi-



vidual – most chalked it up to worry and grief, but a few who knew him well knew something was seriously wrong.

Brown grew up in Chester, less than a half mile from the Chester Mounds on his family farm. He spent an unremarkable childhood playing in and around the mounds, and was well known in town as a bookworm. People had fond memories of him, until his return in 1985 and the strange turn of events that gave birth to his cult, the New Star Crusade, and his new name Danen Ignis. Few understood his motivations, and they were chalked up to greed or insanity equally.

Brown's father, Charles "Chip" Brown was known as a local oddity; and for nearly twenty years before his confinement to what would become his death bed, was known to walk every night at the mounds, often talking to himself. Before his self-isolation and slow descent into madness (harmless as it had been) Chip was a well-liked individual who spent his evenings in the local pool hall "shooting the shit".

Chips' descent seemed to begin after his son's departure in the late 1960's. In truth, Chip's obsession with the mounds had driven his son off, and kept the two from speaking for nearly fifteen years. Michael Brown returned home twice between 1984 and 1985 to see his bed-ridden father, and each time he returned to the University, he seemed more and more distracted and distant.

With his father's death in 1987, the farm – which had been gathering random lost individuals from a round the globe for some time – officially became home to the New Star Crusade, and Michael Brown changed his name to Danen Ignis.

Since 1987, Ignis has held court at the Brown Farm, fighting various legal battles to allow his "religion" to perform rites at the Chester Mounds.

Since the legal kaffuffle involving Douglas Yale – the Ohio River Killer – Ignis has not left the farm. He lives a life of isolation, surrounded by devoted followers, sitting on a stockpile of legally purchased weapons that make the local authorities decidedly nervous.

## The Headquarters Chester's Jonestown

The Brown farm sits on twenty-five acres of land to the west of Chester, Ohio. The property backs up on the Chester Mounds site; and a well-worn path runs from the ramshackle buildings of the Brown farm to the Mound site.

### The "Death" of Michael Brown

During two trips back to the family farm in 1984 and 1985, much of what had been Michael Brown changed. At the urging of his dying father, Brown went out to the mounds at night and waited. There his mind was changed.

Agents digging into this angle of investigation can find many people at the Ohio University in Athens, Ohio, who knew Brown and witnessed his "illness" developing first-hand.

According to former colleagues and friends, it was between these two visits that Brown began changing. His countenance shifted from an affable outgoing person into a dark, brooding soul.

The last time he was seen before his "conversion" by one of his colleagues was in 1986, when he traveled to the University to pick up the remainder of his personal effects. This colleague, Brenda B. Muckelroy relates "it was like he looked at me and had no idea who I was, like Michael was dead, like this was a new person altogether.

He looked at me like I was a problem to be solved."

The buildings of the farm were once sane and ordered; that much is clear, but they have long since degenerated. The main house, a three story, four bedroom affair is now home to over twenty listless followers of the Crusade as well as Ignis himself. The house's powder blue paint has fractured and peeled, showing a dull, split-wood grey beneath it. The roof sags, the gutters are overfilled and at least half of the front porch is beyond repair; ruined by summer rain.

The top floor is a master suite occupied by Danen Ignis himself (nearly everyone in the town knows this, due to his habit of standing on the adjoining patio naked). The windows are whited out with what appears to be latex paint and an assembly of various



weather equipment and electronic antennae jut from its roof. At night, the paint is lit by a dull glow.

The farm has long since stopped functioning; there are no animals or livestock. Instead, the barn is filled with another twenty-six followers who live on army surplus bunk-beds and share three chemical toilets stashed on the wall away from the road.

Five beaten cars haunt the driveway, most overflowing with random assortments of dry-goods (there's no room in the house or barn for them). Occasionally one will drive into town to purchase more food and supplies for the cult.

A small weather-beaten port-a-potty converted to use as a tollbooth oversees the entrance from the main road. Someone is always here, watching those coming and going. A cheap wireless intercom system (one which is easily spied upon) is employed here to see who is, or is not, given permission to enter. This intercom communicates directly to Ignis.

Most activity on the farm occurs at night. During the day only lone individuals are spied wandering the grounds. At night, groups of followers can be seen from the road walking back and forth between the main house and barn.

Cult members walk the perimeter at all times of the day and night, whipped into a frenzy by Ignis' declarations of their pending godhood. They do so unarmed except for a concealed flare gun. They are instructed to fire the flare in case of trouble. When this happens (and it never has, yet) the cult is instructed to arm itself "and come to its brother's aid".

## The Guns Lots of Guns...

Over the years, the New Star Crusade has purchased nearly 2,300 firearms – all legal – ranging from modern handguns to long-bore classic bolt-action rifles. These purchases were carefully monitored by Ignis and were all carried out in a wholly legal manner at gun shows throughout the state. Every member of the cult has been issued a gun permit, and has taken a state-run gun safety course.

There are strict rules at the farm as to who can have guns and when. Only those in the house carry pistols. Guards on the periphery of the farm remain unarmed except for flare guns.

Ignis is certain that the guns "will be needed in the future" and that "the time will be evident when they shall be issued to the followers". Although Ignis does

not know it, his brush with the Degenerate Serpent Man at the mounds has given him a glimpse of the possibility of all the Serpent Men waking and descending on Chester; this has led to his obsession with firearms.

If, indeed, the creatures stir and attack, the New Star Crusade will be one of the only places prepared to repel such an assault.



## Meeting with Ignis Just Knock

Meeting with Ignis is as easy as approaching the main gate and announcing that the Agents want to meet with him (of course the Agents will have to show identification). As simple as that, the Agents will be escorted by listless cult members into the dilapidated farmhouse.

Ignis is a corpulent, bored looking man clad in a one-piece cotton toga-like outfit, treated with reverence by the cult members that surround him like pets.

Ignis' acquiescence should not be considered cooperation; he's a very clever man. He will record the conversation with the Agents and then have them "looked into" by his rather pricey lawyer in Cincinnati. If there's anything to be found (i.e. the Agents are on vacation miles from their jurisdiction) Ignis will find it – though it may take some time (on a successful LUCK roll, it takes 1d6+2 days for him to track down the Agent's dirty laundry).

Ignis will be forthcoming with his beliefs (he does, in fact believe the New Star Crusade mantra he spews), and will attempt to convert the Agents. He'll warn that "forces in the Mound are evil", and that the cult's worship is necessary to keep them contained.

Strangely enough, Ignis would make a fine DG friendly, one capable of both monitoring the

mounds and in case of disaster, mustering enough weapons to defend the town. He also is smart enough to keep his mouth shut. But few Agents will be able to see past his “cult leader” status to make such a call.

### Sneaking into the Farm Wrong Side of the Law

Sneaking on to the Farm and spying on the Cult is much more difficult. During the day it is virtually impossible, as there are dozens of eyes trained on the Farmhouse and barn. At night, it's a bit more probable, but still difficult.

Agents must make a successful SNEAK roll. Those failing cause a cult member patrolling the grounds to become suspicious and allow them a SEARCH roll of 40%. If the Agent fails and the cult member succeeds, the cult member fires a flare gun and alerts the whole farm.

Within minutes twenty armed cult members will converge on the spot where the flare was fired. They will not fire unless fired upon.

If this is not significant enough to scare the Agents off, the police will arrive shortly thereafter. Needless to say, if the Agents are operating under the radar and they're found on the property, they could be in BIG trouble.

### Lawyers Richard A. Goldfarb and Associates

This Cincinnati firm serves several clients, but the lion's share of its attention goes to the New Star Crusade – or more specifically – Danen Ignis. Goldfarb is down-to-earth individual with no belief in the supernatural; and thinks (though he would never admit it) that Ignis is a fraud; not that this keeps him from cashing his checks.

Goldfarb spent thirteen years as a Public Defender in Cincinnati and made quite a reputation for himself. He quit his position and opened his own firm when long-time client Michael Brown began asking more and more of his time – handling estate transfers, and later, dealing with the Chester police department.

Finally, the work became overwhelming for one person, and Goldfarb hired three lawyers whose full time job was dealing with the intricacies of tax law for the cult (which he calls a “church”), as well as an expert on Constitutional Law. Goldfarb is the cult's

direct contact, but he does very little of the work, preferring to be the threatening voice on the telephone and leaving it at that.

His firm has cut a swath through state courts and is greatly feared – even the vaguest hint of a “Goldfarb Case” is enough to make the state counsel of Ohio switch to public relations mode very quickly. Goldfarb enjoys the power his connections have given him, and he'll take any slight from state or federal government to the limit – suing for slander, libel and other more vague legal concepts at the drop of a hat.

Agents unfortunate enough to cross paths with the tiny, elderly man will immediately be struck by two things – his precision in speech, and his constant allusion to possible suits, cases and transgressions committed by the Agents. Goldfarb does not wait for his quarry to make a mistake, but instead suggests what mistakes they might make, robbing them of maneuverability. He's friendly, but when he speaks he projects the image of a man who understands the whole of the law.

Once Goldfarb's hackles are up, Agents are in deep trouble. The man has access to a vast fortune and will track down any lead, real or imagined, which might give him leverage against a troublesome Agent. He'll call supervisors, directors and even publish news stories about “harassment” in the Cincinnati papers.

If the Agents are wise, and they do some homework, the closest they should come to Goldfarb is the internet...



# The Chester Mounds

## A Shrine to Evil



These ancient earthworks are a mystery. Though scientists believe the Adena mound culture constructed them sometime nearly 3,000 years ago, there is no clear evidence of this culture – they remain a question mark in North American history.

The Chester mounds are set apart from the hundreds of other smaller earthworks of a similar design in that they are both larger and more intricate than usual. The Chester Serpents are smaller than the Great Serpent Mound along the Ohio Brush Creek (they are approximately half the size, when laid end-to-end), but they represent the most intricate design attributed to the Adena culture.

The site is composed of three large mounds, each about 200 feet in length in the shape of an undulating serpent (the serpents are so intricate, they even have tongues). These serpents face inward touching tongues.

These mounds are twelve to fifteen feet high and are easily mistaken for simple man-made hills. Only someone walking the grounds and thinking carefully (or observing it from the air) can get a clear idea of the intricacy of the layout.

### Data on the Mounds Hard to Come By

A surveyor named Clinton Cowan surveyed the mounds in 1901, at the behest of the Ohio Historical Society. This surveyor did little but take exacting measurements and generate the definitive map of the Chester Mounds (just as he had of the Great Serpent Mound). This map is the best information available on the Chester Mounds to date.

Though the Ohio Historical Society opened the site as a park in 1967 along with the Great Serpent Mound Site, its much larger cousin quickly overshadowed the Chester Mound Park. Attendance to the Chester Park was a mere fraction of the huge number of visitors the Great Serpent Mound drew every year.

Finally, in 1971, with a plummeting attendance to the Chester Mounds, the Ohio Historical Society “closed” the park (meaning they no longer paid for tour guides, a small visitors toilet, and a security guard). The Mounds remained protected property under the ownership of the Ohio Historical Society;

however, no one but locals showed up.

For a decade, it was a location where locals went to drink and make out. So much so, it became a common stop for the town’s law enforcement personnel. Occasionally, there were fights there, as well as reports of vandalism.

The Mounds remained this way until the advent of the New Star Crusade in the 1980’s, when they became the focus of worship for the secretive cult.

### Crimes at the Mounds Not-So-Random Violence

Looking into local criminal reports (possible only for a Law Enforcement official, talking to the Chester Police Department) reveals a large number of fights, violence, drinking and sex at the mound, as well as several cases of vandalism.

In fact, these cases date back decades, some even to before World War I.

The most interesting cases involve Douglas Yale, the Ohio River Killer and Arthur Hunt, the town’s most famous son. Both were caught, at one time or another attempting to dig up the mounds.

Yale was caught vandalizing the mounds in 1999 – having dug nearly five feet into one of the snakes’ head – and was interrupted by the sheriff’s deputy.

Hunt was a ne’er do well who was obsessed with the mounds, and often was caught there puttering about; once, in the summer of 1922 with a pickaxe and shovel (and a pint of bourbon). Hunt was incarcerated for a day while he sobered up, but the aging police report indicates Hunt babbled about “gold” being buried in the mounds.

Fights were also common at the mounds. Most were no more than a scuffle, ending with a busted nose, or lost tooth or two, but one in particular, was serious.

In the summer of 1979, Scott S. Cogan beat another boy, Lucas Jeffries to death at a drinking party at the mounds. Cogan, now in his forties, is still serving a 50-year sentence at the Ohio State Penitentiary.



## Testing the Mounds Minor Excavations

Geographical information on the mounds is relatively easy to come by. The earth around the mounds has been surveyed several times, and accurate topographical and soil maps exist at the Meigs county seat in Pomeroy Ohio, 8.2 miles to the southwest.

Giving these maps to a geographer (someone with a Geography skill in excess of 40%) reveals a very plain fact – the Chester Mounds are on a cryptoexplosion structure – a place on the Earth that has been struck by a meteorite.

This is clear both by the bowl shaped “extrusion” that surrounds the entire mound area, as well as the convergence of three disparate soil types in one area.

Actually removing samples from the interior of the mound (1 meter or deeper into the mound) is a risky, illegal operation. Any Agent attempting to do so should roll against their LUCK; on a failed roll they were either observed (their car was spotted and reported, or a cult member happened upon them and reported them). Complaints will either be filed with their law enforcement branch (if they’re in town officially) or a local charge of criminal mischief and vandalism will be filed locally (if they’re in town on the Q-T).

If their LUCK roll succeeds, they manage to remove a sample of the mound. Testing at a lab re-

veals nothing out of the ordinary, and dating the mounds proves inconclusive.

## Digging up the Mounds Minor Excavations

Those foolish enough to attempt a full-bore excavation of the Mounds face several obstacles. Accomplishing even a small excavation is a monumental task. Excavation is possible only at night, for one – those attempting it during the day immediately fail as either a Cult Member or Police Officer arrives to disrupt the work. Those captured by the Cops defacing the mounds are in DEEP trouble. They will be arrested for defacing a landmark, and the Ohio Historical Society will prosecute mercilessly pushing for a maximum sentence of 5 years. Needless to say, those pretending to be “on assignment” who are not, will be found out during such proceedings.



### Talking to Scott S. Cogan at the Ohio State Penitentiary

Cogan is an easy man to get in touch with – he’s not going anywhere for a long time. He was convicted quickly of murder in the third-degree, and offered up no significant defense. He is currently in the Ohio State Penitentiary as prisoner 00067171, and is known by the guards as a forgettable and quiet ward.

Cogan will meet with anyone who shows up to see him, whether he knows them or not. His family turned their backs on him when he was convicted and he hasn’t had a visitor in nearly six years.

Cogan will be forthcoming about his crime. He did it, that much he’s sure – he remembers it all – but why he did it still remains a mystery. He’ll speak very plainly of “the feeling”. He claims he was “overwhelmed” by a feeling that the people around him at the party were a danger to him, and that one, in particular – Lucas Jeffries – was the most significant threat.

Cogan cannot explain it any better than that. He’ll simply (and sadly) repeat that he has no idea why he did it, only that, at the time, it seemed vital he do so. If asked specifically about voices at the mounds, Cogan will break down and begin weeping; drawing the guards in to cut the visit short.

He’ll finally offer up the cryptic line as he’s removed from the visitor’s room “you heard them too?”

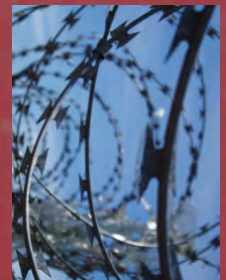

Those venturing out at night in an attempt to uncover what's in the mounds must make two consecutive LUCK rolls. Those successfully doing so uncover one of the interred Degenerate Serpent Men.

Even a full night of digging will only affect a small change on the mounds, and since digging machinery is out of the question (it would obviously draw attention from the cult farmhouse), even eight hours of work will only move a small amount of the mound.

The defacement of the mounds will be discovered the next day and will lead to a police detail staking out the area for weeks.

As such, it's highly likely the Agents will only get one chance to cut into the mounds.

### Destroying the Mounds How Much Dynamite Did You Bring!?!

Destruction of the mounds is a task requiring vast amounts of time, money and access to explosives/earth moving equipment.

Such a task requires a successful GEOLOGY and EXPLOSIVES roll, in addition to 2d10+2 hours uninterrupted at the site. This time will be VERY hard to come by, since many people frequent the mound site.

Bulldozing the mounds is another option, but it is a bad one — in addition to drawing people from the local farmhouse, it will lead to more difficult problems to remedy. Doing so simply wakes the degenerate Serpent Men interred there.

### The Twenty-Five Hibernating Killers

In their hibernating state, they appear as odd, 5' long, deformed fetus-like stone statues (anyone with a BIOLOGY or MEDICINE skill quickly arrives at the conclusion that they are petrified remains of an actual biological creature).

Though the “remains” are somewhat brittle to brute force attacks(they shatter like stone), they don't exhibit the common fragility seen in mummified remains. The creatures are easily destroyed in this state — simply stating the intention to destroy the “corpse” renders it destroyed and inert.

Experts in the field of mummification will state that some sort of “non-standard” mummification proc-

ess was used to create them. Something advanced; such as freeze-drying or another type of water replacement method; as such. Non-enlightened experts will state that the “things” were interred in the recent past (since such methods did not exist previous to the 20th century).

Tests performed on the remains indicate that no known chemical was used for the “preservation” process; DNA samples from the remains confirm that the creatures are not human — their genetic structure does not fall into an easily classifiable category. If submitted to Federal testing, there's a 15% chance that it will be “noticed” by MAJESTIC (see The MAJESTIC Option on page 24 for more details).

But these creatures represent much more than the shadow of a threat; they are not actually dead. Left un-interred for a day (one sun/moon cycle) the creature will “wake” in a weakened but still quite deadly state, and begin hunting much like Xa, the previously freed Serpent Man; following his modus operandi to a “T”. However, this is by no means an “instant” process.

After two or three hours above ground, those observing the remains begin to notice a change in their coloring. After hour 6, water begins to bead on their bodies (even in a humidity controlled environment). After hour 19, the faintest signs of biological processes can be “heard” within the bodies.

The last hour shows movement in the extremities, culminating with the creature “waking”. Living beings within clear view of the “remains” when it wakes, will feel overcome by fatigue suddenly (everyone present loses 1 point of POWER).



# The Hunt Museum

## A History of Hunt in Chester



The Hunt Museum is a sleepy, rarely visited piece of history in the center of Chester. It's slowly dying, losing support as a landmark and getting less and less local funding each year. Right now, the Parsons Plastics company is the main supporter, but the future of the museum remains uncertain. It maintains various artifacts from Arthur Hunt's past, including technical drawings, some devices, and the original Hunt Mark 1 Resistor — the device that put Chester on the map. It also houses nearly 100+ photographs of Hunt throughout his life; including one taken three days before his death in 1952.

Mary Jarrard, a 52-year-old historian is the director and sole employee of the museum. When called upon, she gives tours, rearranges displays and cleans the 2,200 square-foot facility (in fact, cleaning is what she spends most of her time doing).

Jarrard is a local expert in all things Hunt, and will be forthcoming and open with anyone in authority — allowing them to examine any item in the museum in detail; under her supervision. She'll even remove objects from their display cases for Agents to look at more closely.

She has been assembling a comprehensive book on Hunt's life, and the eccentricities of that life — from a native Chester, Ohio perspective. Her book, which is not yet titled but is nearing completion, tracks the rise of Chester Ohio and the rise of Arthur Hunt. Only with a great amount of groundwork (Agents must make two successful LUCK rolls on two different occasions while “sweet talking” her) will Jarrard allow Agents gain access to a copy of the book.



### The Untitled Hunt Book

Jarrard's book is rough (often blank in places save for cryptic notes on future additions), but it does contain some interesting facts: including the last and only interview with Allan Mestemacher; Hunt's assistant on Chester; before his death at the age of 91 in 1999.

The rest of the book is irrelevant, the main “meat” is the Mestemacher interview. It clearly mirrors Monty Greene's testimony in Hellbend (see page 27). Mestemacher discusses Hunt's predilection to eating only vegetables, his fear of blood, and his obsession with tinted glasses. He also indicates Hunt spent much of his time talking in a “language I have no way of knowin', like speaking in tongues”. Hunt seemed to consider Mestemacher “unimportant” and did not put on his “act” when only Mestemacher was around.

In town, Hunt acted as a quiet, introspective individual that went out of his way to avoid conflict or interaction of any sort. At the Hunt farm, he was a tyrant, often shouting at Mestemacher for the slightest inconvenience or mistake. He never injured Mestemacher, but he lived in constant fear of the strange man. This fear could not kill curiosity however.

On occasion, Hunt deigned to show his servant things which were disturbing and seemed to defy science. On one occasion, Hunt had Mestemacher run a quarter of a mile out into a field, jam a steel cone into the ground, and wait. A quarter mile away, Hunt did the same, and when his master bent and spoke into the steel cone, Mestemacher could hear him through his cone, as clear as day. Mestemacher remained certain that Hunt would release this invention; but it never came to pass. This item is now on display in the Hunt museum, mistakenly identified as portions of a toolset.

Mestemacher spied on Hunt's travel plans; digging through itineraries and maps Hunt had marked up when he knew his master was out. Hunt made a circuit of the Mediterranean; stopping at major ports. He bought ancient books, though Mestemacher has no idea what they were (though, he notes, one was in Greek) as well as various “Egyptian artifacts”. Where those artifacts and books might be

today remains a mystery.

During the later half of his life (after 1941), Mestemacher became a devoutly religious man; obsessed with the devil and hell. The interview with Mestemacher is telling, inasmuch as the old man seems to tie huge importance to Hunt and his choice of “Hellbend” California for a new home.

Mestemacher made no bones about it; he believed Hunt was a devil from Hell, if not the devil himself. Mestemacher never explained how he had come to this conclusion, but would only confirm “I know, I saw...”

### Arthur Hunt in Chester The Prodigal Son

Arthur Hunt is a local legend in Chester. He’s the “success-story” of the town, almost the inversion of Douglas Yale, the Ohio River Killer. Hunt rose from poverty and a life of debauchery in Chester to forge an electronics empire that has stood the test of time – surviving even after his unexpected death in 1952.

But at first, no one in town thought much of him. In fact, he was considered a local ne’er do well – someone more prone to theft, violence and lying than any productive endeavor.

Hunt was born to an unwed mother – Emily Harris – on October 19, 1906 in the McMurtry Railroad station (which would later become the Chester train station). Sent from Chicago to live with an elderly aunt in disgrace, Emily Harris arrived in the then tiny bump in the road called Meigs county (it had not yet been officially settled as Chester) just minutes before her water broke. She named the child Arthur Hunt, after his absent, and never again to appear, father.

Margaret Harris – the aunt – lived in a farm nearest to the Chester estate, some four miles from what would become downtown Chester in the following decades. Emily was welcomed into the house, as was the child, the aunt held no preconceptions, but in 1909 Emily ran off, never to be seen again, leaving the child behind.

Margaret raised the unruly youth as best she could, but Arthur was a violent, simple-minded child. He was a known troublemaker, ejected from the local school on more than one occasion, for fights and worse. It was rumored he couldn’t read and write properly.

By the end of the Great War, Arthur Hunt was 12, and had taken to alcohol. He left school the follow-

ing year, as the Influenza epidemic swept the newly forged town. Hunt was unaffected, but his aunt fell ill, and though she survived, she remained bedridden from 1919 until her death in 1921.

During this time Hunt held several short-lived jobs, including a counter-boy at the local Five and Dime, a street sweep and an ice delivery man. None lasted more than a few months. In his 15th year, his aunt died, leaving him a sizable estate, the house, and livestock.

The newly christened Hunt Farm fell into ruin over the next few years. Since 1920, Hunt had maintained his sizable booze habit illegally, purchasing liquor from local criminal contacts. During this time, he began to associate with hoodlums in the county, including a Shawnee Indian named Saucy Jack – a drunken rumrunner who drove the backwoods in a souped-up Ford.

Jack and Hunt became partners of sorts, frequenting the often-ignored Chester Serpent Mounds to drink, play cards and shoot. By 1922, the local police noticed this activity, and on May 3, 1922, Hunt was discovered at the mounds, drunk, carrying a pickaxe and shouting drunkenly about Shawnee gold. Hunt was incarcerated, but it was known in town he still visited the mounds. Soon after the arrest, Saucy Jack and Hunt had a falling out, and the Indian was not seen in the county again.

For nearly a year Hunt rarely appeared in town.

On April 9, 1923, Hunt changed. He returned to town and settled into the newly finished Chester Public Library, and began to read. This first vigil lasted eight hours and soon drew spectators. Hunt read books on nearly every subject, and remained mute, refusing to engage with questioners and on-lookers. As he read, he seemed to grow faster; soon he was reading each page with a glance of only a second or two.





When the library closed for the evening, Hunt left as easily as he had come, vanishing into the woods, reappearing at opening each morning. He ate and drank nothing during his reading, and kept up this cycle unceasingly for three weeks. Locals remained split on Hunt's motives – most thought it was a complex con, others that Hunt had finally seen the error of his ways. Rumors began to spread that Hunt had quietly “home-schooled” himself during the previous years.

By week three, Hunt began speaking with the locals, and it was as if his entire personality had changed. His voice was quiet – monotone – without any humor in it. His English was precise and ordered. His interactions were brief, and to the point. Hunt ordered a list of 200+ items from the local five and dime, including drafting tools, a table, various metals, torches and workbenches, as well as various radios sets. He paid in gold; which was odd, but not totally unheard of.

Hunt disappeared to the Hunt Farm, which, over the next year and half transformed into a clean and orderly place. Hunt meticulously replaced everything, down to the gate to the road, though, oddly,

he sold all the livestock. The electric lights he had installed in 1924 were among the first along his stretch of road, and soon, every room in the house burned with an incandescent bulb.

Hunt hired a local farmhand named Allan Mestemacher to run errands for him in town, and Mestemacher became the local conduit for Hunt gossip. The man was working ten hours a day on drawings of complex electrical devices, and building bizarre electronic contraptions. This continued for several years, until it was assumed it would continue this way indefinitely, then, as suddenly as he had first arrived at the library, Hunt arrived in town again, filing papers to incorporate “Hunt Electrodynamics”. On the same date, he submitted three thick envelopes to the U.S. Patent Office, and several letters to far-flung corporations in Europe and America.

Within months, Hunt had forged several lucrative deals with various electronics firms, licensing various small components to them, including Westinghouse and Consolidated Edison. He continued to operate from his farmhouse, and now began to make national news. His company posted large profits and its paperwork was meticulous. Considering Hunt was its sole employee, it was considered amazing he could complete all the paperwork himself as well as continue to create and patent inventions.

Hunt's biggest hit, the Hunt Mark I Resistor, was debuted on August 5, 1930, and rocketed the one-man company into the stratosphere. When Hunt realized he could make far more money producing the Resistor, he opened a local Hunt Electrodynamics plant. Soon, the plant was the largest employer in town. It was during the first few years of the Chester Plant that Hunt began traveling.

His trips took him far and wide, though almost no one in town knew where he was going. Mestemacher reported that Hunt returned from his trips with odd books and items from around the globe, and stickers on his trunks indicating he had been to Istanbul, Casablanca, Cairo, Catania and elsewhere. By 1938, rumors began to spread that Hunt was planning to leave Chester.

When it was discovered that Hunt had been constructing a town in Death Valley, California – one of the most inhospitable places on Earth – no one was really surprised; nothing about Hunt could strike the townsfolk as odd anymore. Hunt was considered an eccentric, at best, and downright strange at worst; but few had anything bad to say about the man. Announcements were made that the Chester plant

would remain in operation, but Hunt would leave for California.

By 1940, Hunt was living in Hellbend, California permanently, and was largely forgotten in Chester; trotted out only as an interesting story from time-to-time. With Hunt's mysterious death in the Hellbend explosion of 1952, the Hunt Museum was constructed in Chester to celebrate its most famous, and successful son.

## The Photographs A History of Mystery

The 100+ photographs of Hunt feature only four taken before his "rebirth" in 1923. Each show Hunt in various states of intoxication; including one during the celebration of the end of the Great War where Hunt has climbed a light pole with his pants down.

60+ photos show Hunt in Chester, Ohio after 1923. In all of them, his expression is identical; a look of bored detachment. His eyes are passive and strange. He is well kept and clean, though his posture is odd. When standing, he seems to stoop his head forward in a way that seems out of sorts for a young man.

The remaining 36 are varied Hunt Electrodynamics promotional shots, showing an impassive Hunt standing before various constructions around the US, including the facility in Hellbend at its opening.

The last photo, taken three days before the Hellbend explosion in August 1952, shows something unusual. Hunt, his face usually implacable, seems to be smirking.

There is also another oddity evident in the photos, since they are displayed sequentially – from 1923 to 1952, despite a gap of almost thirty years, Hunt appears exactly the same; as if he had not aged a day in the interim.

## The Artifacts Mundane and Not-So-Mundane

Almost all of the artifacts in the museum are mundane. The Mark 1 Resistor, for example, is totally normal and within the realm of conventional science.

However, there is one supernatural item on display, mixed in amidst a set of tools in a display entitled "Hunt's Toolset". Amidst miters, saws, die-cutting tools and various hammers and chisels is a stained, aged metal funnel. In actuality, it is two funnels, one

inside another. Anyone making an IDEA roll, or a SEARCH roll while checking the display will recognize that they don't belong there. Those who have seen Aklo characters before gain a +15% to this roll.

If removed and examined, they appear to be simple metal cones, open on both ends, made of a strange alloy (something like Bronze, though tests on it will prove inconclusive). On the tapered end of the cone, the opening is bisected by a complex arrangement of wire. This wire traces out a symbol (Aklo; if the Agents have already encountered the language – for more details, see "Aklo? What the Hell is Aklo?" on page 11).

If both cones are stuck in the earth (in soil or soft ground), despite the distance, anything said into one can be instantly and perfectly heard from the other. This "geophone" operates through hypergeometrical principles that are beyond modern understanding, but nevertheless makes it possible to instantly communicate between any two locations on the planet.

Physicists (those with a PHYSICS skill of more than 25%) must make a SANITY roll when watching the devices operate (-0/1d4 SANITY). As it provides a perfect and secure basis of communications, A-Cell will be most interested in such a device.

## Records One Signature, Two People

Records of Hunt in town include various arrest records pre-dating 1923, a birth certificate, his name on the deed to the long demolished Hunt farm, and little else. His handwriting is a childish scrawl – the signature of someone who obviously has a poor grasp of language.

Post 1923, examples of Hunt's writing are everywhere. It is block-like, angular and mathematical, though his signature remains the same clumsy scrawl. Copies of the papers incorporating Hunt Electrodynamics are available, and show the same methodical code-like writing.

Hunt's plans on display at the Museum exhibit Aklo characters in place of normal lettering. A plaque notes this "code was used to thwart attempts at theft and fraud."

It's a well-known fact that most of Hunt's real paperwork left Ohio with Hunt in 1940; and is assumed destroyed in the 1952 Hellbend explosion. All that remains in the museum are the smallest scraps of thousands of engineering schematics and documents Hunt drafted in town.

## The Statue 12 Feet of Bronze

Hunt's statue is a 12' bronze statue on top of a hollow cement pylon in the center of town. It sits at the heart of the Malcolm Chester Park, and faces west, towards the Mounds. The statue is unremarkable, and was sculpted by Alan Melendez (deceased) of Chicago Illinois in 1953, and unveiled in 1954. Hunt Electrodynamics paid for the original statue (as well as the museum).

Though it may lead to some suspicion, the statue is completely mundane and has no connection to local supernatural events. Cracking open the base will reveal nothing, except a 1950's Pabst Blue Ribbon can.



## The Old Plant Nothing to See Here

The old Hunt Electrodynamics Plant sits to the south west of town. It was a large facility for its time, with nearly 1,000 full time employees. It is a series of low brick buildings, a large loading/shipping dock, a closed railroad spur, and a large, largely overgrown parking lot.

The HE sign is still in place, but the ruins are long since overgrown with rust, vines and weeds. Every window has been broken. The tar roofs on many of the buildings have collapsed from the winter snows.

The local authorities frown upon wandering around the buildings – after an injury in 1988, a large fence with razor wire was erected surrounding the entire site. Since the plant is removed somewhat from the town, cutting through or carefully traveling over the fence is quite possible. However, there is nothing to be found here.

Though this does not mean it's devoid of adventure – Agents arriving at night might surprise a group of teenagers drinking in the ruins, and an interesting game of cat and mouse can take place. The teenagers will be certain the Agents are the local police, and the Agents might mistake the teenagers (attempting to hide) as something connected to the case.

## Green Hills The Old Age Home

The local old age home – Green Hills – is located four miles from town. Agents using their identification can gain access to the facility easily, and walk around normally with guest passes. Those undercover will have a harder time; and must either be a family member or the guest of a family member to interact with one of the retirees. Posing as one is not as hard as it might sound, as long as some footwork and fast talk is done.

The residents range in age from 61 to 101, many of whom were alive and in their prime when Arthur Hunt ran Chester, Ohio. Talking to most of them reveals little about Hunt that can't be found elsewhere in town. Still, they paint a clear picture of the time – of working for Hunt Electrodynamics when it was a worldwide name.

Few, if any, met Hunt. His status as town recluse will be clearly recollected, as well as his habit of appearing (when he did) randomly and on his own terms. When he was seen, it was usually at a distance, and usually at night. Residents will indicate they know one man who knew Hunt, if only before his amazing transformation.

One man, Gary Hearston (age 99) was a schoolmate of Hunt at the Chester School before his expulsion, and witnessed Hunt's "rebirth" in 1923. Hearston is very clear-minded, and is certain that whatever happened to Hunt that year, it completely changed him. The man after 1923 bore absolutely no relation to the man before 1923, save his physical appearance. He didn't even recognize Hearston.

Hearston worked at the train station for thirty years as a porter; and was employed at the station when Hunt began shipping large amounts of items in and out of Chester; items he was forced to move. The principle port-of-call on these crates seemed to be Istanbul.

Besides the general concepts gotten across by the elderly here, and Hearston's testimony, there's nothing else of interest.

## The Ohio River Killer That is not dead...



Despite numerous sensational books on the subject, few solid facts on Douglas Yale exist. In actuality, Douglas Yale never committed murder – but in his place, the doppelganger Serpent Man Xa did, 8 times before his capture, and 8 times after the confirmation of Yale's "death".

Yale's childhood – what of it is known – is the standard tale of no father, a drunken mother and poverty. Yale experienced various brushes with the law throughout his life, and this did not stop when he hooked up with the New Star Crusade. As his nightly walks at the mounds affected his mind, Yale degenerated slowly into madness – despite this, he was never truly homicidal, just deranged.

Yale's name has become synonymous with Ted Bundy and the Son of Sam in the area – and numerous television shows have been made about the murders, due mostly to their brutality and cannibalistic nature. Despite the Serpent Man's continuing murder spree few in law enforcement have noticed. Xa has both grown hungrier and more fastidious in its hunting methods, hiding what little remains after his feasts with great care.

Douglas Yale was ejected from the New Star Crusade when Ignis realized his charge had lost his

mind. Yale – still in the sway of the Serpent Man – lived in the woods near the mounds and went there at night. Finally, Xa managed to ensnare him fully, and on a summer night, forced Yale to free him from his tomb. The Serpent Man consumed the unfortunate Yale and became him.

Even after Yale's bones were discovered in October 2001, murders in the area continued – but few connections to the previous cases existed. Delta Green even investigated the oddities of the Yale case briefly in 2002, when a friendly from a local Cincinnati news station alerted Agents to a possible supernatural event in the area. But nothing came of it.

To most in the area, the Douglas Yale case is old news – something akin to Jeffery Dahmer or Richard Speck – yet another in an endless series of lost people looking to matter in the world. Few give a second thought that Yale survived a huge shootout unscathed, or escaped from a secure prison cell and killed an armed Sheriff's Deputy.

To locals, it's just another version of the same old story.





## Xa Degenerate Serpent Man

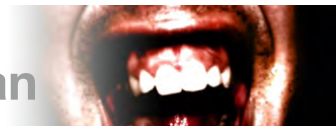

### History

Released by Douglas Yale in 1999, this creature has been mentally preying on the locals near the Chester Mounds for a long time. Since 1923 (with the disturbance of the mound when its master was woken), this creature has been “conscious” but trapped within the mound, desperate for release. Its twenty-five “brothers” remain hibernating within the mounds.

Over the decades, it has slowly “fed” on the power exuded by the minds of those who visit the mounds. At first, it could only do so on solitary individuals, and could exhibit control over those with a natural mental instability. It couldn’t do much except “watch” and slowly siphon power from lone visitors, but by the late 1970’s it had gained enough power to “touch” people.

It corrupted Chip Brown during his lonely walks to the mound in the 1970’s and later, his son during his similar walks near the mound in the 1980’s – giving birth to the New Star Crusade.

It moved Scott Cogan to kill Lucas Jefferies in 1979, and later, Douglas Yale to become even more violent, antisocial and crazed than he was naturally. Finally, it drew Yale in and in a fit of crazed digging forced the madman to free him.

It then consumed and became Yale, kicking off a series of brutal cannibalistic murders from 1999 to 2001. It still haunts the county, and now that Yale is believed dead and the Ohio River killer case is closed, it kills with impunity.

### Appearance and Behavior

Xa can appear as any of its 16 victims, ranging in appearance from a 6-year-old girl to Deputy Arthur Falstaf. It can cycle through these forms in seconds, but no matter its disguise, its shadow remains that of its true form (any light source more significant than a candle and a SEARCH or IDEA roll from 01 to 15% reveals this terrifying fact, and costs 0/1 SANITY).

Without a disguise in place, it is a squat pale creature approximately 5-feet tall, which stands upright like a man, but with long, muscular arms tipped by crude hands with basic prehensile thumbs.

Its skin is the texture of a tire, shot through with crimson splotches, but otherwise it’s white and pearly. Its face is two huge vulpine eyes, a slit for a nose and an un-hingeable jaw that can drop and open to accommodate a vast amount of meat.

It does not appear even vaguely human, and anyone seeing it must make a SANITY roll or suffer 1/1d6 SANITY points damage.

Its hunting style has developed over the years. It realizes the basic facts – humans have overrun the world, and they are more advanced and dangerous than the humans it last knew from the Adena culture. They have weapons and abilities that it does not fully understand, though it knows humans are often armed with technology that can cause serious injury at a distance (guns). It does not understand



how any human technology works however – such things are simply beyond its comprehension.

Xa hunts by walking on backroads at night as some of the more vulnerable looking disguises – a little girl, a young woman, an old woman, waiting for a human to approach it. Due to the crude nature of its disguises, such illusions appear unclothed, and are often startling for those who come across them. It has learned that humans are social to the point where they will ignore signs of danger until it is far too late. It has killed 8 individuals in this method in the years since its capture and escape.

The creature's main weakness is blood. While gorging, the creature enters a torporous state – akin to a heroin high – where it is eminently vulnerable and unable to protect itself. This occurs only after the killing is “done” and the victim is to be digested. Such digestions often take more than two-weeks, during which time the creature is completely immobile. It usually drags off its prey to one of several “dens” in the woods where it can digest it unmolested.

Xa is quite content to hunt like this indefinitely, but if pushed to the limit (hunted incessantly, injured on more than one occasion by Agents who seem to understand its abilities and limits) the creature will retreat to the mounds to unearth “back-up”.

It is more than willing to wake its sleeping brethren from the mounds and descend upon Chester Ohio in a killing frenzy, hoping to drive the humans off. Such tactics worked for its kind in the distant past, until the humans became too numerous and powerful, and as a last-ditch plan, it can muster up little else.



# Stats for Future/Perfect 2

## The Players

### DEA Agent Rigoberto R. Young Agent FAWKES

**Race:** Hispanic, **Education:** J.D. Law **Occupation:** DEA Agent, **Age:** 39, **Height:** 5'11", **Weight:** 201 lbs, **Hair:** Black, **Eyes:** Green  
**STRENGTH** 12 **SIZE** 12 **CONSTITUTION** 15  
**DEXTERITY** 11 **POWER** 8 **APPEARANCE** 10  
**INTELLIGENCE** 11 **EDUCATION** 21

**HP** 14 **MP** 8  
**SANITY** 35  
**IDEA** 55% **LUCK** 40% **KNOW** 105%  
**DMG BONUS:** 0

**SKILLS:** Administration 11%, Biology 19%, Chemistry 45%, Computer Use 61%, Conceal 31%, Credit 22%, Cthulhu Skill 9%, Dodge 20%, Drive Automobile 35%, Law 52%, Listen 24%, Search 45%.  
**LANGUAGES:** English (own) 100%, Spanish 45%  
**ATTACKS:** Punch 25% (1d4)  
S&W 1076 Semi-Automatic, 44% (1d8+4)

### Police Sergeant Stephen Moreno Agent FRANK

**Race:** Caucasian, **Education:** B.A. Ethics, Police Academy Training **Occupation:** Sergeant Cincinnati Police Department, **Age:** 41, **Height:** 6'1", **Weight:** 221 lbs, **Hair:** Brown, **Eyes:** Brown  
**STRENGTH** 13 **SIZE** 15 **CONSTITUTION** 15  
**DEXTERITY** 15 **POWER** 12 **APPEARANCE** 16  
**INTELLIGENCE** 10 **EDUCATION** 18

**HP** 14 **MP** 12  
**SANITY** 45  
**IDEA** 50% **LUCK** 60% **KNOW** 90%  
**DMG BONUS:** +1d4

**SKILLS:** Administration 31%, Chemistry 12%, Computer Use 31%, Cooking 10%, Dodge 13%, Drive Automobile 39%, Ethics 31%, Fast Talk 41%, Law 20%, Persuade 51%, Psychology 25%, Search 53%, Swim 29%, Track 12%  
**LANGUAGES:** English (own) 90%  
**ATTACKS:** Punch 51% (1d4+1d4)  
.38 Snub Nose Revolver 60% (1d10+2)

### John Maskenogi Two-Faced Writer

**Race:** Shawnee/Caucasian, **Education:** B.A. Literature, **Occupation:** Author, **Age:** 45, **Height:** 6'3", **Weight:** 240 lbs, **Hair:** Black, **Eyes:** Green  
**STRENGTH** 13 **SIZE** 18 **CONSTITUTION** 16  
**DEXTERITY** 8 **POWER** 3 **APPEARANCE** 6  
**INTELLIGENCE** 10 **EDUCATION** 21

**HP** 15 **MP** 3  
**SANITY** 15  
**IDEA** 50% **LUCK** 15% **KNOW** 105%  
**DMG BONUS:** +1d4

**SKILLS:** Accounting 21%, Anthropology (Shawnee) 31%, Computer Use 42%, Dodge 11%, Drive Automobile 37%, Local Knowledge 25%, Search 12%, Writing 51%  
**LANGUAGES:** English (own) 100%  
**ATTACKS:** Punch 61% (1d4+1d4)

### Danen Ignis (Michael Brown) Leader of the New Star Crusade

**Race:** Caucasian, **Education:** M.A. Literature **Occupation:** Former Teacher, Now Cult Leader, **Age:** 60, **Height:** 5'9", **Weight:** 225 lbs, **Hair:** White, **Eyes:** Blue  
**STRENGTH** 10 **SIZE** 14 **CONSTITUTION** 18  
**DEXTERITY** 17 **POWER** 10 **APPEARANCE** 7  
**INTELLIGENCE** 18 **EDUCATION** 20

**HP** 14 **MP** 10  
**SANITY** 40%  
**IDEA** 90% **LUCK** 50% **KNOW** 100%  
**DMG BONUS:** +1d4

**SKILLS:** Art (Literature) 39%, Computer Use 29%, Drive Automobile 36%, Geology 19%, Hide 11%, History 27%, Law 35%, (Shawnee) Mythology 31%, Persuade 45%  
**LANGUAGES:** English (own) 100%, Latin 25%, French 29%  
**ATTACKS:** Punch 35% (1d4+1d4)  
.30-06 Springfield Rifle 65% (1d10+8)

# Stats for Future/Perfect 2

## The Players 2

### Average Member of the New Star Crusade 46 Wayward Followers

**Race:** Varies, **Education:** Everything from No Schooling to Graduate Degrees **Occupation:** Followers, **Age:** 18 to 57, **Height:** Varies, **Weight:** Varies, **Hair:** Varies, **Eyes:** Varies  
**STRENGTH** 9 to 18 **SIZE** 10 to 18  
**CONSTITUTION** 9 to 17  
**DEXTERITY** 7 to 18 **POWER** 5 to 17 **APPEARANCE** 6 to 18  
**INTELLIGENCE** 9 to 18 **EDUCATION** 9 to 21

**HP** 9 to 17 **MP** 5 to 17  
**SANITY** Average Sanity of 50%  
**IDEA** 50% **LUCK** 50% **KNOW** 50%  
**DMG BONUS:** -

**SKILLS:** Cooking 30%, Cleaning 35%, Cult Teachings 50%, Listen 30%, Meditate 25%, Search 34%

**LANGUAGES:** English (own) 50% (other languages as well)

**ATTACKS:** Punch 50% (1d4)  
.30-06 Springfield Rifle 50% (1d10+8)

### Xa The Inhuman Ohio River Killer

**Race:** Serpent Man, **Education:** None **Appearance:** Varies (can appear as any of its 16 victims)  
**STRENGTH** 17 **SIZE** 12 **CONSTITUTION** 19  
**DEXTERITY** 18 **POWER** 18 **APPEARANCE** 3  
**INTELLIGENCE** 10 **EDUCATION** nil

**HP** 16 **MP** 18  
**ARMOR** 2 (-2 HPs from every incoming attack)  
**DMG BONUS:** +1d6  
**SANITY** 1/1d6

**SKILLS:** Forage 30%, Hide 61%, Human Culture 31%, Listen 68%, Scent 55%, Stalk 60%, Track 90%,

**LANGUAGES:** Aklo (verbal only) 45%

**ATTACKS:** Claw 49% (1d6+1d6)  
Bite 25% (1d10+2+1d6)

**SPECIAL ABILITIES:** Xa can instantly take on the appearance of any human it has consumed; this

illusion is a perfect magical disguise based on ancient Serpent Man rituals, but it does not imitate clothing. Xa has become somewhat acclimatized to the 21st Century. Despite being overrun by mammals, it quite likes the quality of prey it has found in the modern era.

### The 25 Degenerate Serpent Men

**Race:** Serpent Men, **Education:** None **Appearance:** These 25 appear in their native form until they can consume a human victim  
**STRENGTH** 14 to 17 **SIZE** 9 to 12  
**CONSTITUTION** 12 to 19 **DEXTERITY** 15 to 19 **POWER** 10 to 18 **APPEARANCE** 3  
**INTELLIGENCE** 10 to 15 **EDUCATION** nil

**HP** 13 to 18 **MP** 10 to 18  
**ARMOR** 2 (-2 HPs from every incoming attack)  
**DMG BONUS:** 0 to +1d6  
**SANITY** 1/1d6

**SKILLS:** Forage 30%, Hide 61%, Human Culture 31%, Listen 68%, Scent 55%, Stalk 60%, Track 90%,

**LANGUAGES:** Aklo (verbal only) 25 to 45%

**ATTACKS:** Claw 20 to 49% (1d6+DB)  
Bite 10 to 25% (1d10+2+DB)

## Maps for Future/Perfect 2

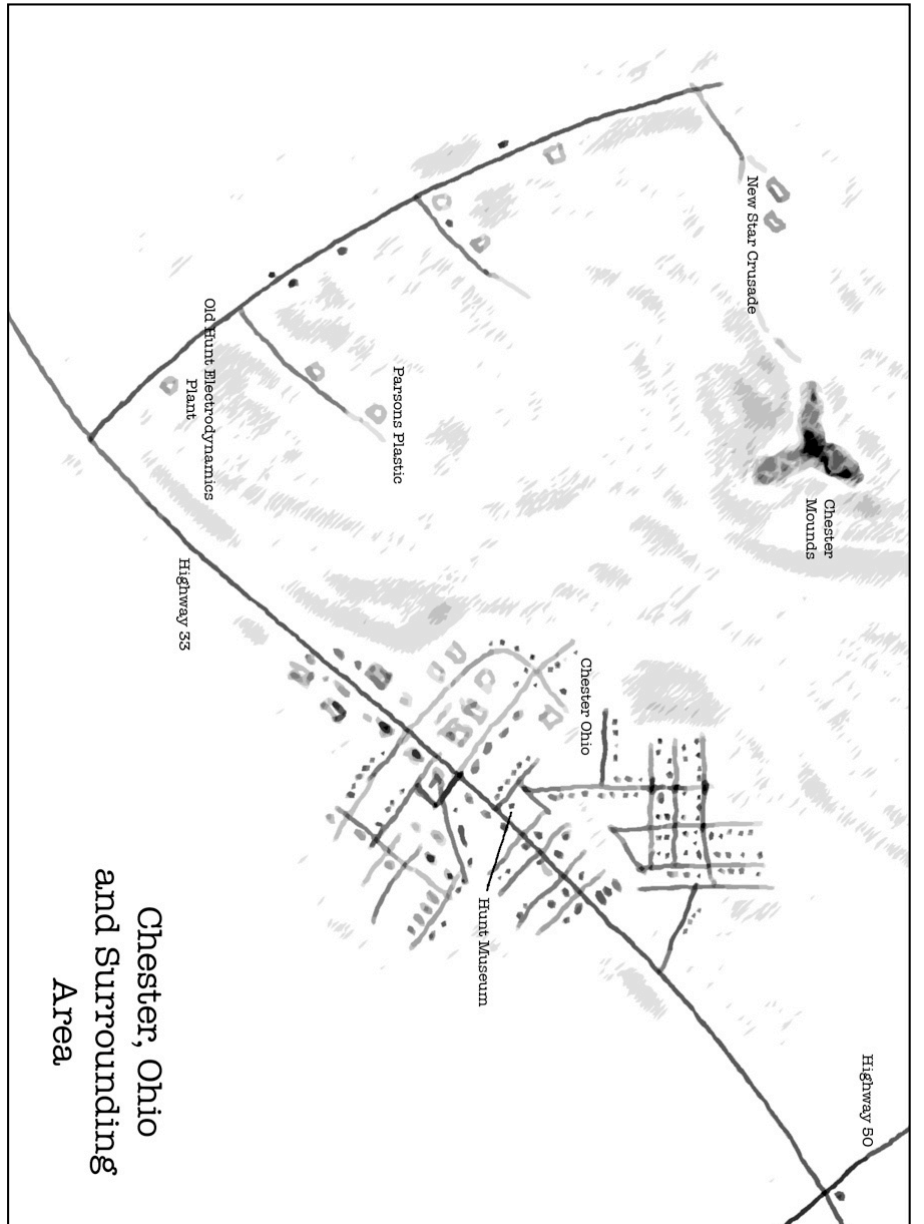

# DELTA GREEN FUTURE/PERFECT 3

DELTA GREEN: FUTURE PERFECT 3

## Part 3 of a Delta Green Campaign

Wherein  
hypergeometric  
principles  
warp the  
Human Heart

ALL TEXT IN THIS PDF  
IS ©2006 DENNIS  
DETWILLER. DELTA  
GREEN AND ALL RE-  
LATED CHARACTERS  
ARE ©2005 THE DELTA  
GREEN PARTNERSHIP.  
THIS IS A FREE, NOT  
FOR PROFIT PDF. THIS  
PDF MAY BE PRINTED  
AND BOUND FOR  
PERSONAL USE ONLY.



## FUTURE/PERFECT PART 3 DUXBURY, PENNSYLVANIA

By Dennis Detwiller

### Welcome to Duxbury, Pennsylvania, Hunt Electronics Territory The Ultimate Company Town

Duxbury, Pennsylvania. For 35 years, it has been shrouded in secrets.

Since 1971, Hunt Electronics has owned the town. In a manner not unlike HE's founder, the deceased Arthur Hunt, CEO William Lassiter bought the town, piece by piece; and he paid enough money so the locals are more than happy with the deal.

Like Hellbend, California, the town was brought into the company fold, and now that it is there; safe and warm, it will never be the same again. People are happy, the schools are good; the company takes

care of them. There is no crime.

But in the last ten years accidents have plagued the plant. Twelve people have died, tens of millions of dollars have been invested, and thousands of man-hours put into the task at hand. But there's just one problem — no one outside the plant knows what they're doing at there, exactly.

The task at hand is clear only to those on the inside, and they're not talking.

They don't build things, because shipments never come out. They just go in. It's not a data center or a think-tank, because communication to the outside world is restricted. It's not some sort of treatment plant, because it's just a series of plain looking buildings scattered across one of the most secure com-

pany sites on the planet.

Only William Lassiter seems to know, exactly, what it's all for.

But HE reports record profits year after year, and behind closed doors at the privately held corporation the select group of management plan their next steps. For the last four years, the rumor is this — William Lassiter has informed the workers to expect great things from the Duxbury Project.

Arthur Hunt's dream to 'change the face of the Earth' seems to be alive and well with the company elite.

## Connecting Part 1 or Part 2 to Part 3

### A Web of Lies

At some point, it is likely they Agents will look into the current state of Hunt Electronics. Although HE has corporate offices in many locations, Duxbury, Pennsylvania will quickly become the focus of any diligent Agents — it is the focus of HE's "project". This project has been the subject of numerous articles, news reports and stories for the past 10 years, but so far, no one outside the company has any idea precisely what's going on in Duxbury. What is known is this — it's expensive and Lassiter is certain of its success.

If the Agents are left without leads after parts 1 or 2, A-Cell can easily get them involved. Post Hellbend, something as plain as an indication from A-Cell that the machine which leveled the Hunt Electrodynamics plant in 1952, might be currently under construction at Duxbury Pennsylvania right now, should be enough.

Alternatively, following the Chester investigation Agents who have poked into the back-history of Arthur Hunt might see analogs between William Lassiter (the current CEO of HE) and Hunt himself. The Duxbury project's subject is secret, but its existence is not, and Lassiter's obsession with the subject has been third-string public news for some time. In that way Duxbury bears a remarkable resemblance to Hellbend, California, prior to the disastrous explosion of 1952.

Alternatively, beginning Part 3 with the bust of HE employee Jonathan Emery at LaGuardia Airport by TSA officials for the concealment of 200 pounds of unrefined gold remains a startling and clever way to bring the Agents in to Part 3.

## Starting with Part 3

The possibly most compelling option involves *beginning* the entire Campaign with the bust of HE employee Jonathan Emery at LaGuardia Airport. The revelation of a low-level clerk at HE transporting 200 pounds of gold to Switzerland, hidden in engineering equipment while on company business can open up Duxbury as a clear method of entry.

Unfortunately, this also can launch an alphabet soup of Federal agencies right to the heart of the Duxbury Plant, as well as the inhuman secrets that lie within it. Containing such a mess will be no mean feat. Making certain such a mess goes unnoticed by the darker elements of the Federal government will be a miracle.

If you begin with Part 3 set the Jonathan Emery bust in the present — something that occurs just a day before the players become involved.

## The Skinny

For the past twenty years, the Duxbury Plant has been home to a hypergeometric gate reconstructed from the Serpent Man Arthur Hunt's alien notes. It is identical in function to the Hellbend gate, but unlike that gate, is stable. It is now in common use by an elite cadre of personnel hand-picked to establish an outpost in the distant past; the one "safe" location discovered in twenty years of experimentation.

The CEO of Hunt Electronics William Lassiter has become obsessed with the gate and Hunt's history. He is convinced some earthly catastrophe is coming, and that the gate and the outpost the company has set up in the past is humanity's only hope. The gate has also been the key to his financial success — through the gate, tons of unrefined ores (gold, platinum, silver) have been returned to the present day. This currency has been secretly moved to offshore banks, and covertly reported as legitimate profits. Being a privately held company, few questions have been asked.

Lassiter is CERTAIN other beings like Hunt exist in the world — they may even be in control of the government — and will take no chances. He is willing to do *anything* to maintain the integrity of the gate, and has sanctioned blackmail, murder and cover-ups to protect the company's secret.

Lassiter is a zealot, who has seen much in his life to convince him that what is commonly thought of as ridiculous (spirits, aliens, time travel) is not only real, it is practical and exploitable.

Any day now, he is certain, creatures like Hunt will return, and using their advanced technology, subjugate and enslave humanity. With the hundreds of hours of video of alien creatures from the past, as well as hundreds of biological samples, Lassiter is certain there is more in heaven and earth than anyone knows for certain, and is prepared to give his own life to protect the secret of the gate.

## Running Part 3

Part 3 of *Future/Perfect* represents a *very* open scenario, as such it's written and handled differently than the previous two chapters. Instead of detailing particular *occurrences* it details the characters, locations and activities of those involved in the Duxbury conspiracy, and tries to address points of entry that Agents might take.

Listed below are the common problems possible in an open-ended scenario, along with several suggestions on how to handle them in case they come up.

### Slowdown

Sometimes a scenario seems to slow down to a crawl — with no leads, action or engaging threads for the Agents to pursue. There are several ideas that can kick-start a slowing scenario:

1. **Death:** An accident claims the life of Duxbury personnel, opening a new avenue of investigation. There is unusual legal finagling about surrender of the man's body, which is eventually handed over to the coroner. The body is crushed to the point where every bone in his body is pulverized, and his skin is split by pressure. The cause of death is listed as "Water Pressure Die Cutter" accident; but sea water is found in the man's lungs.
2. **Hit:** An Agent is targeted for execution by anonymous "mechanics" hired by Jim Avary through untraceable means. These killers are effective, skilled and coordinated. Only the quick or the lucky survive.

### Dead End

Sometimes Agents are too efficacious and exhaust nearly every obvious lead far too fast. As such, unleashing one of the following on them should renew the mystery.

1. **Quake:** The local area is rocked by an anomalous 3.2 earthquake. Local scientists are baffled, but dogged research reveals the epicenter of the quake to be *exactly* 150 meters below the Duxbury plant Building B.
2. **Disease:** People begin getting sick. This mysterious "fever" pops up in town and quickly claims the lives of 10 children. The CDC is immediately brought in to study the case after a plant-like substance is found in the bloodstream of two of the children. The only common denominator in the case seems to be the Duxbury plant.

### Peak Too Soon

Agents might be clever enough to rapidly organize a raid on the Duxbury plant. It is important to note than for the last twenty-years William Lassiter — the CEO — has been expecting such an occurrence. The plant will not simply roll-over to local police or even Federal authorities. As far as every employee at the Duxbury plant is concerned; everyone on the outside might be the pawns of the "others"; the Serpent People they know haunt the modern world.

Contingencies are in place to lock-down the facility into a veritable fortress, a location unlike any raided by Federal authorities before. They cannot hold out forever, but can turn what would normally be an affair that might last a day or two into a month-long standoff riding the headlines of CNN — something no DG Agent wants.

### Revelation

This odd outcome *is* possible, but rare. A meeting with CEO William Lassiter where Delta Green's cards are laid on the table *might* gain his trust, or even his eager cooperation, depending on circumstances. In truth, Lassiter is *building his own Delta Green* — an organization to save humanity from supernatural threats, while hiding the truth from the world at large.

If Lassiter's trust is gained, an exchange of intelligence "as a show of trust" will be initiated. Lassiter will be forthcoming with everything but the gate — his ace in the hole.

If the Agents do manage to recruit Lassiter as a "friendly", this is a major victory, and the focus of the scenario should be switched to "damage control" — covering up the oddities of the HE Duxbury plant, including the arrest of Jonathan Emery and the 200-lbs of gold at LaGuardia airport.

It won't take much for MAJESTIC to begin sticking its nose in, and once they sense a threat, it will take everything the Agents have to keep them from consuming the secrets of Duxbury. (see page 24 for more details on MAJESTIC involvement).



## The Bust Jonathan Emery, Fall Guy

On a gray Monday morning a young 22-year-old employee of Hunt Electronics, Jonathan Emery was detained and questioned by TSA officials at LaGuardia Airport in New York City. He was pulled aside in a random search, and quickly drew the suspicion of his interrogators with his evasive answers and nervousness.

During his questioning, the nearly 750-pounds of engineering equipment he was shipping to Switzerland was searched. The equipment was supposedly specialty “testing devices” for a subcontractor in Berne. A quick check on this story proved it was false – there was no subcontractor in Berne, and arrangements had been made by Emery for a car to pick him up at the airport.

Found within each device were hidden compartments filled with roughly melted gold ingots, totaling nearly 200 lbs., with a rough value of over 1 million dollars. This stunning revelation opened a veritable landslide of questions. Emery had very few answers.

Emery was not charged, but was held by Federal Authorities. Emery immediately promised total cooperation. He claims (and his story has proven true) that he has made a similar trip twice a year for the last two years.

Emery is employed at the HE New York offices, and though he knows about Duxbury, he has next to no insight as to what might be going on there. He DOES know the equipment came from Duxbury, and that the bonus he received each time he made a



trip was exorbitant; to the point where he felt uncomfortable accepting it. Each time he travelled to Switzerland, he received a cash pay-out of \$5,000. Still, money is hard to ignore.

Emery did his best to overlook the warning signs. By his third trip he was fairly certain he was doing something illegal. The main give away besides the pay-out were the rules — don’t open the cases for any reason, always check the luggage as “specialty equipment”, never let the luggage out of your sight once on the ground, and the final rule — bring the luggage by specialty van to Credit Suisse Bank in Berne.

Once at Credit Suisse, the luggage was taken away by attendants (overlooked the whole time by white gloved men with sidearms). Emery was given his cash, and sent on his way. Often Emery would spend days in Berne, and even travelled much of Europe two trips before.

Emery knows he is in deep trouble, but so far, has no idea what he was moving. His guesses — money or drugs — are not too far off, but still, to experienced investigators it’s obvious he has no idea what’s going on.

Emery is simply the messenger — the man with the key into the heart of HE’s greatest secret; Duxbury, Pennsylvania...

Duxbury, Pennsylvania	Facts
Area	37.62 Miles
Population	9,248 (2000 Census)
Founded	1810
Industry	Engineering/ Research (Hunt Electronics)
Temperature	High: 98 F (36.6 C), Low: -10 F (-23.3 C)

## William Lassiter CEO of Hunt Electronics Clever and Beguiling

William Lassiter is a quiet legend — a man about whom many stories, exposés and speculative documentaries have been made.

Born in 1947 in Ann Arbor Michigan, he was an excellent student who excelled at all things mathematical. He never married.

Lassiter began in business as a hand-picked protégé of Thompson MacAfee — the man who succeeded Arthur Hunt as leader of the company after Hunt's untimely death in 1952. After a chance meeting following a speech, MacAfee brought Lassiter into the company straight from the University of Pennsylvania at the tender age of 20.

It was clear to all that Lassiter was the heir apparent, even from his earliest days at the company, when he was put in charge of "Special Projects".

Lassiter made some prescient predictions about the direction of consumer electronics, and more and more was given control of Hunt Electronics' most important divisions.

By the time he was 30 in 1977, Lassiter ran the company for MacAfee, who had long since "retired" to a desk job in New York. This transfer of power was made official on October 28, 1977; when Lassiter became CEO for Hunt Electronics and Thompson MacAfee retired.

Lassiter took the company in new directions immediately. Huge amounts of HE resources were diverted from defense contracts to component production in the burgeoning home computer business; which, at the time, was in its infancy.

Over the next 30 years, Lassiter maneuvered his company completely unscathed through the volatile electronics sector, banking record profits, securing new and lucrative contracts and doing business the only way HE is known to — behind closed doors.

Lassiter is known as a strange, distant individual — eccentric, but not stupid, who is both feared and admired in the business world. He makes his home at Duxbury, in a large estate on a hill overlooking the plant — which he has stayed in less and less as the years have gone on.

Setting up a meeting with Lassiter without any legal pretense is an absolute impossibility. His social calendar is necessarily packed, his business calendar,

doubly so. Without a warrant, or some legal angle into HE, Lassiter is beyond approach. With evidence of wrongdoing on the part of a Hunt Employee, a warrant, or any "legal" angle, Lassiter will be forthcoming — even polite.

Agents will be brought in to lavish offices in Duxbury (outside the plant in town) where they will be subjected to every courtesy and kindness, and then escorted into a vast boardroom.

In the boardroom, they will meet William Lassiter, a small, quiet man whose intelligence is stamped upon his wide, wise face.

Lassiter will be disarming and kind, working his way into the kindnesses of even the most grave Agents. He has not maintained his position for 30 years through his lack of social acumen.

If the Agents at any time *threaten* Lassiter, they will see the other reason he has maintained such power. Lassiter will make plain that any legal move to implicate HE in wrongdoing will be met by a team of lawyers suing each Agent individually for slander, libel and worse crimes, as well as suing every state and federal division involved in such an investigation.

He will state this in the manner of a man stating that the Earth moves around the Sun: it is a fact. However, those Agents hoping to pin such crimes on a HE employee operating outside the auspices of HE direction will find Lassiter once again cooperative and kind.

Lassiter will produce all manner of perfect evidence to indicate not only that such an employee was being investigated by HE itself, but that Duxbury police also had a file on him. (For example photos of Jonathan Emery illegally moving components from the Duxbury facility will be produced — and, coincidentally, such components contain large amounts of gold).



## Lassiter's Hobbies

Quiet research into Lassiter's hobbies will reveal some oddities. Beginning in the late 1970's Lassiter started purchasing antiques — including antique books and artifacts from all over the world.

His most significant purchases have topped the 1 million dollar mark, though unlike most magnates of his type, Lassiter does not lend these items to public institutions, instead keeping them for himself at an undisclosed location.

Lassiter will not answer to this hobby if directly confronted with it, instead indicating "I have many hobbies: I'm a collector at heart." He'll then change the subject.

His purchases include:

### The Turner Papers (English, 1789 AD)

*A series of papers examining the impact of one Adolphe Friest — of Swiss extraction — who terrorized a small Connecticut town with "sorcerous acts" and was finally burned as a witch.*

### The Litke Papers (Russian, 1828 AD)

*Russian notes from the first white men to land on Ponape in the South Pacific. It covers the islander's religion — including their belief that reptiles can eat and become people.*

### De Vermis Mysteriis (Latin, 1226 AD)

*The "Mysteries of the Worm" — detailing "the worm that walks". In this case, Worm is a word for serpent or snake. It describes, in detail, the ability of "Worms", as well as their weaknesses (bright light, reflections, shadows etc...)*

### The Aves Reflector (Object, Approx. 1660 AD)

*An odd object recovered in Belize. It is a burnished bowl of an odd highly reflective metal. Local legend indicates it can reveal those hiding in superhuman disguise.*

### Quetzacoatl Codex (Aztec, Approx. 1525 AD)

*An original Aztec codex noting the rites to Quetzacoatl, the feathered serpent; the god of mathematics. This is in original Aztec pictographs, and is damaged by fire.*

### Les gens du reptile (French, Approx. 1651 AD)

*A French text — "The People of the Reptile" — outlining an odd offshoot of Christianity which revered serpents. Their leader was a man called "Adolphe F." who disappeared before the cult was shattered by church authorities.*

### The Necronomicon (Greek Translation, 1199 AD)

*No introduction necessary — this version of the book (which influenced De Vermis Mysteriis) seems to focus on "the worms of the Earth". These beings are supposedly hidden among mankind, and represent a much older race, often mistaken for demons, witches and angels.*

## On the Radar Mistakes and Consequences

Lassiter is both aggressive and effective in dealing with threats — real and perceived. Agents who are persistent in pestering Lassiter will find the hammer falling on them from several directions at once.

Lassiter will attempt legal recourse first, pulling strings. Agents who are officially on the job (those who have somehow had themselves legally assigned to the case at hand) will find themselves leaned upon by higher-ups who urge them to "redirect the investigation". There is never any talk of why, and likewise no talk of closing the investigation, only redirecting it to members of HE who are operating outside HE authority.

Secondarily, Agents who *continue* find themselves served with subpoenas to legal proceedings indicating slander. These suits are private — not against the federal government, but *that Agent as a private citizen*. Lassiter's lawyers are a vast cadre of company men who will do everything they can to extend, confuse and blur the reality of the situation. They are asking for damages in the millions of dollars. Such cases, though they hold no merit, could easily bankrupt the average Agent.

Third — and this only occurs if Lassiter's men discover the Agents are not officially sanctioned (which can happen quite readily in any DG investigation) — more *dare* means will be employed in quieting the Agents.

After a period of time where the Agents are tailed (roll vs. SEARCH to note the tail), they will be isolated and either made to disappear or turn up as a mysterious suicide. Usually, this will only need to happen to one Agent; the others should get the hint.

The individuals hired to complete the task are experienced, anonymous and deadly. They have no direct connection to Lassiter and will die before revealing their involvement in a conspiracy; see stats for such operatives at the end of this scenario on page 92).



## Jim Avary Duxbury Head of Security

Those attempting to meet Lassiter will notice his shadow — Jim Avary — Duxbury's head of security. Avary has worked for Lassiter for 22-years, following a stint as a security contractor for various defense companies around the world.

Since beginning at HE, Avary has risen to become Lassiter's right-hand-man. He oversees both Lassiter's personal security as well as security for the Duxbury plant.

Avary is a veteran in his 60's, having served two tours in Vietnam in 1969 and 1970 with the Rangers. He is thin and short, but resilient, and should not be underestimated. He will not hesitate to use deadly force and simply accept the consequences. It is likely that nearly any pretense of a threat to his employer — along with world class lawyers — will be enough to get him off.

Most importantly; he knows all about the Duxbury gate. He is a zealot for Lassiter's cause, and will give his life to protect it.

Avary rose to prominence in the company following his introduction to the (then unfinished) gate and his rooting out of Lewis Ahmed; an employee of the company with access to nearly all the company's research on the science of the gate who turned out to be... not human.

Avary's research into the matter of Ahmed determined that the scientist had been "replaced"



through unknown means during a visit to New York, and that the threat had been caught in the nick of time (the first gate activation was only a few weeks away).

Following this discovery, large amounts of heavy weapons were quietly purchased on the black market, and Avary's team of "brownshirts" were created — these mercenaries, like Avary were exposed to the "secret threat" that hung over the modern world. They too are zealots, *certain* that the threat to the world is both very-real and growing.

"Ahmed" remains in custody in the depths of the Duxbury plant, and is Lassiter's lynchpin in "recruiting" new members to his cause. The creature is kept under 24-hour armed guard in a specially constructed vault. Despite various attempts by the creature to escape, it has remained in custody now for the last 21-years.

Avary is never far from Lassiter, and outside the plant, is his constant shadow, usually flanked by a half-dozen or more "Brownshirts" armed with folding machine pistols, sunglasses and secret-service-like attitudes.

Those approaching Lassiter in the outside world will find themselves instead face-to-face with Avary, who will intercept and deflect their attempts at uninvited contact; despite any credentials they might flash.

Agents foolish enough to draw weapons on *anyone* in Lassiter's entourage will find themselves outgunned — usually by a factor of 2. (Those in this position should roll a LUCK roll, failure means gunplay begins).

Avary *does* respect authority, when it is properly applied. Those attempting to contact him through his personal secretary will find him cooperative, even friendly, and he will gladly arrange a "tour" of the Duxbury facility.

## Security Obsessive and Compulsive

The Duxbury plant is a 2.5 acre section of land located outside of the town proper. It is surrounded by two-deep 20-foot security fences topped with razor wire. Every fifth fence-pole is topped by a swiveling security camera monitored 24-hours a day by Avary's brownshirts.

There is one main gate which is "airlocked" — separated into its own section by a series of fences — overlooked by two cement buildings with bullet-proof glass which look surprisingly like bunkers. Only delivery trucks enter this gate however.

All personnel park *outside* the facility in a black-topped parking lot which is walked by security every 25-minutes. There, employees exit their vehicles and walk to the main gate. At the gate they enter one of the two security buildings.

In these buildings they are subjected to something called "flashing". One-by-one individuals enter a small room and are subjected to extreme UV light. This is easily covered up as "destroying microbes which might damage sensitive materials in the plant"; in actuality, this is a room designed specifically to stop creatures like "Ahmed" from entering the plant again.

All personnel are observed on camera in the security office when their shadow is cast by such rays — Serpent Men in disguise cast their own shadow, and not that of their disguise; a fact known to Avary and others, thanks to his extensive researches into the

occult.

Once through the flashing process, employees are issued a one-day badge with a 256 bit unique security code (Agents stealing a badge and making a successful COMPUTER USE *and* FORGERY roll can duplicate such a badge, but it will only work *that day*). Cracking the code of a future date is not possible without access to a single computer in the security office which is always manned.

Such badges open only "permitted" doors in the facility, and all such activity is logged. Signs everywhere read "ONE BEEP, ONE PERSON" indicating that when passing through doors, each person must wait their turn and swipe their security card individually. Avary and Lassiter hold the only cards which permit more than one person to travel room to room in the plant. Anyone attempting to sneak another person through a door with themselves will trigger a silent alarm and alert security.

Inside the facility, nearly every area of the two enormous buildings (Building A and B) are manned by brownshirts, all linked to a central command by a secure communications net.

Of the two buildings, almost all activity seems to take place in Building B. Building A seems relatively sedate comparatively (this is visible even from outside the plant, but only to those conducting more than 2-days of surveillance). Building B is the home of most of Duxbury's oddities, including the gate, the inhuman "Ahmed" and hundreds of biological samples recovered from ancient Earth.



Building A, which will be the building Agents are escorted to if they manage to finagle a tour, is a carefully constructed “red herring”. Portions of Building A are clearly separated and marked “Off Limits” — in these areas highly sensitive looking equipment that Agents with an ELECTRONICS skill in excess of 30% will recognize as microchip stamping devices in the 65 nanometer range are concealed, usually flanked by white smock wearing personnel.

Those attempting to get a peek behind the curtain are permitted (though attempts will be made to stop them), and following a successful sighting, subjected to legal wrangling culminating in the requirement of the signature of a Non-Disclosure Agreement.

Smart Agents will recognize this as a ruse — security in the building is *extremely* tight except for the moment they try to poke their noses behind the curtains. Avary is hopeful such a ruse can quiet any outside concerns the Federal government might have.

## Ahmed The Snake in the Box

Captured in 1986, this being — called Rhashass — is a Lesser Serpent Man; not a degenerate but a juvenile. It survived the fall of the Hyperboria nearly 1.1 Million years ago by fleeing to equatorial Africa to escape the creeping ice. Later, it entered a voluntary torpor.

It is from a different time period than Xichlasa — the Serpent Man who would become Arthur Hunt — but its morality and motivations are similar.

For five-decades since its “awakening” in the Middle East in 1902, the creature had been working on a method to restore the ancient kingdom of the Serpent People or at least, effectuate its own return to that time.

In 1952, through the use of hypergeometry, the being discovered the fluctuating explosion of the Hell-bend Gate.

Since that time, the creature had jumped through many human disguises, studying the company and its leadership, with the ultimate goal of gaining access to its highest levels.

During this time, it constructed several devices used to track, change and maintain a gate; these were captured on its “person” by Duxbury security personnel.

This plan culminated in its “consumption” of Lewis Ahmed, a materials scientist, during a trip to New York in 1986.

The creature *became* Ahmed and returned to the plant in the hopes of accessing the gate; instead, it was outed and captured alive by Jim Avary and a team of brownshirts.



### Alien Mind

Agents confronted for the first time with direct evidence of an alien creature (as opposed, to say, a Monolophosaurus or other terrestrial being) must make an IDEA roll (in addition to any SANITY rolls).

Those that succeed at the IDEA roll, successfully fit the creature into their particular world-view — for example, a UFO obsessed Agent might immediately assume a Serpent Man was an extraterrestrial until further evidence was uncovered.

Those that *fail* have a much harder time. They cannot account for such a creature existing on some fundamental level of their psyche, as such, they are subjected to nightmares, fatigue and stress on levels not usually experienced.

Agents subject to this effect must make a SANITY roll each night. If they succeed, they sleep normally, if they don't *all skill rolls the next day are -10%*. Only impaling a SANITY roll will stop this effect from happening.

Despite its hypergeometric “scrying” on the plant, it failed to realize the gate was not fully active yet, only in the earliest phases of testing.

It had expected to make its way to the gate and simply escape, not to find the gate partially disassembled undergoing testing.

Jim Avary noticed the odd activity on Ahmed’s security card and confronted the being along with six brownshirts.

One brownshirt, Irving Thewliss was killed in the struggle. Only after Thewliss was killed did the fight turn in favor of Avary and his crew. The being seemed to become docile once it tasted blood (this weakness has been used as a natural foodstuff/ sedative against the creature).

Since that time it has remained under constant armed guard in the depths of the plant; kept alive by invasive medical means and studied by four physicians.

Its containment cell is the last stop for new recruits — a undeniable alien creature — the last nail in the coffin of any doubt a new employee might have. Nearly every HE employee at the Duxbury plant has seen Ahmed, and has left that room shaken to their core.

This containment cell is accessible only to six ID badges — Lassiter, Avary and the medical personnel that care for the being.

Ahmed has been systematically tortured for information over the last twenty-one years and has revealed much of what it knows — which is not much.

HE employees have puzzled the operation of Ahmed’s devices out of the being, and have used them to great effect in maintaining and monitoring the stability of the gate.

Hundreds of hours of tapes are kept in the vault, containing endless interviews conducted by HE personnel with the creature. In these tapes, the creature confirms all of Lassiter’s worst fears — Hunt was not human, there are dozens, possibly *hundreds* of other beings like Ahmed and Hunt loose in the world, and that they are all driven to return to their own time; *or to restore their kingdom on modern Earth.*

The creature is isolated behind plexiglas in a special holding device which keeps its thin, odd, snake-like limbs locked in an X position.

It is approximately 7’ long, from the tip of its foot to the top of its head and is obviously an alien creature (-1/1d8 SANITY). It appears to be reptilian in nature, and looks like a huge snake fashioned into the vague likeness of a human form with primitive looking prehensile thumbs. It has two large blue eyes which never blink, and are lit with an alien intelligence that is disturbing to look at.

Its skin looks resilient, with the consistency of a thick tire, and is mottled with a yellow-green color reminiscent of vipers.

It has no range of movement, and is obviously sickly. Despite this appearance, it is still terribly strong, and if freed, would make quick work of anyone foolish enough to release it.

## The Brownshirts Dangerous and Smart

The “brownshirts” — called this because of their unofficial uniform of black suit and khaki shirt — are a team of ex-military, ex-bodyguard personnel handpicked by Jim Avary to defend the Duxbury Plant from infiltration. They are officially called the “Security detail” and are on-record as a force of workers to prevent industrial espionage/theft.

For such a small facility the number of full-time security personnel is vast — 55 full-time and 20 part-time brownshirts are employed in the plant. Of a total workforce numbering in the 550 employee range, this number is startling (nearly 1 in 7 personnel works in security).

These men are experienced, most are blooded killers involved in armed conflicts around the globe such as the first and second Gulf War, as well as far-flung places like Kosovo, Somalia and Panama.

Avary is particular about these individuals — they have no families, no criminal records and no ties to the outside world such as religion. *All* have been exposed to both the gate and Ahmed, and have become true believers in Lassiter’s cause.

They serve 72-hour shifts where they spend 8 hours on, 10 hours off. These shifts require the brownshirt to remain at the plant, and when not on duty, they are either in the commissary, the barracks, or the amenities room. Almost all have houses in Duxbury, and many have taken to “doubling up”, with multiple personnel sharing a single house or apartment.

In town, they stick together at standard masculine activities — football, pool, etc... There are no female brownshirts.

This tight-knitted-ness works both ways, Avary is first to know when a new relationship with an “outsider” begins, and when any “anti-company” traits arise in his men. Such urges are easily quashed through cash, perks or a reminder of just what’s at stake.

They are very close, and Avary likes it that way. He has gone out of his way to develop an *esprit de corps* and is known to give generous bonuses, promotions and other perks to those who work hard in his service.

All the brownshirts have also been promised a place on the far side of the gate in case of catastrophe, a raid, or invasion. As such, they have had extensive training in defense of the facility in case of outside attack. Avary has trained them to expect the worst.

Contingencies are in place for a folding defense of the plant, where heavily armed personnel hold the line against an outside incursion while vital people and equipment are moved through the gate.

On-duty, all brownshirts wear an ear-piece connected to a 25-band encrypted radio which is connected to security HQ. Most are armed with pistols while on duty at the facility, outside, they often carry machine-pistols with folding stocks. All are trained in defensive-driving, hand-to-hand combat and small arms.

They never work alone for long. They operate in teams of up to three, and are in constant contact with security HQ. When an alert is sounded, they will act in quiet concert, with multiple teams folding in on any target, rapidly closing off any escape route the subject might be contemplating.

Brownshirts are briefed daily on any relevant news (say, for instance Agents might be “touring” the facility). There are no real secrets in the group. To outsiders, they seem like robots, strange and unfathomable. Their motto is “Think and Act in Equal Measure”. Those in town speak highly of them; they are clean, quiet and spend money that keep the bars, restaurants and stores in Duxbury afloat.

When alerted to outsiders in the plant, brownshirts adopt a “smile and silence” attitude, staying out of the way, and only speaking when spoken to. If asked odd questions, they will refer the questioning party to the public relations officer and politely smile.

Agents that encounter them in this state might mistake their intentions at a later date. It’s one thing to have a security guard shooting at you, it’s another

thing when he does so just hours after telling you to “have a nice day”.

## Duxbury Personnel Life on the Cutting Edge

The 550 full-time Duxbury personnel are *all* true believers in William Lassiter’s mission. They are very similar in countenance, behavior and personality — few have any family (those that do are not close to them), nearly all are single (the few who are married or in relationships are involved with other HE employes) and every one left various high-paying jobs around the world for Duxbury.

They are experts in their fields, ranging from quantum mechanics to microbiology. Many were hired through the recommendation of friends already employed at the plant.

The list of employees and their disciplines might seem odd (the staff includes two paleontologists and one linguist) but company PR documents explain these away. For example the paleontologists are being used in robotics research — working on new artificial legs, and the linguist is pursuing a new generation of voice recognition technology. Every one has personally witnessed the creature they call Ahmed, and with evidence like that, it’s difficult to deny Lassiter is on to something.

The personnel are divided into three “teams” — Blue Team, Red Team and Green Team. Blue Team is in charge of the physical plant, maintenance and security (all brownshirts belong to Blue Team). Red Team is in charge of physical sciences and research.

Green Team is the most coveted position, as they work “offsite”; the universal term for the facility on the far side of the Duxbury gate. This term is bandied about often, but details are never given. All Duxbury personnel live in the town or the surrounding area. Their shift structure (except for Green Team, which employes a monthly rotation) is the same 72-hour, 8-hours on, 10-hours off structure as the brownshirts.





# Getting Inside

## The Impossible Dream



Many Agents will immediately look for a way to infiltrate the Duxbury plant — this is easier said than done. Barring some supernatural method of entry, even the most experienced Agents will find *all* their facilities taxed if they hope to get inside undiscovered.

The options are outlined below and examined in more detail on the pages following.

### Through the Wire (p 74) A Very Bad Idea

There are generally three types of breaking and entering possible: disguise, distraction or simple infiltration. Unfortunately, none of these is very effective.

Anyone with an appropriate skill (SECURITY, COMPUTER USE, ELECTRONICS) examining the plant from a distance can make a skill roll. Those who succeed come to the conclusion that the plant is just too well guarded to attempt any of the more common types of breaking and entering.

Those who fail such a roll believe they have found a loophole in the system — such as a weak-link in the fence set-up, a “hole” in the number of guards during a shift etc... Unfortunately, such a belief is simple folly. The plant is well guarded 24-hours a day.

### The Raid (p 76) A Warzone in the Making

A Federal raid on the facility seems to be a no-brainer, however, anyone watching the facility for more than a full-day realizes the security is run like clock-work.

Anyone with a MILITARY SCIENCE or otherwise appropriate skill can make a single roll for each day of observation.

A successful roll reveals the signs of a carefully constructed folding defense for the plant. Men set up in careful patterns designed to hold off an attack while others retreat towards more hardened, strengthened defenses.

This is enough to give any veteran a clear picture of the bloodbath a full assault on the plant will be. (However, it might be fun if *someone else* from the

alphabet soup of agencies was planning a raid and the characters had to *stop* them).

The only chance a raid might have of getting to the main buildings without resistance is a carefully coordinated sniper strike — taking out all the individuals standing guard at one time. Even then, the assault on the buildings themselves will inflict a terrible toll.

### Hostages (p 78) A Decent Bet

The one thing that keeps the Duxbury Plant focused in one fanatical direction is William Lassiter, the CEO. Everyone in the facility knows him on a first name basis and he is the “founder of the feast” so to speak.

He is considered by almost all the employees as nothing short of the saviour of mankind. Most would willingly give their lives for his safety or at least put themselves in harm’s way to prevent his capture.

Also, Jim Avary is a central figure in the lives of the isolated workers in the Duxbury Plants. Most will go above and beyond for him as well.

These two men, however, are very difficult separate from their heavily armed entourages. If the Agents somehow do manage to get their hands on one or the other, they have a good chance of getting inside.

### Negotiation (p 83) The Surprising Best Bet

Agents smart enough to approach the armed camp with a white flag might get to parlay with Avary and Lassiter directly.

Clever Agents can side-step a huge bloodbath and gain something DELTA GREEN has never had access to: an active gate to the past.

This sort of coup is what great ops are made of, and as such, should *never* be easy to accomplish. Agents should have to work hard to achieve such a beneficial outcome.

## Through the Wire A Very Bad Idea

There are three different ways to illegally gain access to the Duxbury Plant. None of them are very safe.

Agents with experience in the field (that is, those who have seen any form of action, or who have training on raids, etc...) should make a KNOW roll. Those who succeed at this roll get the classic “bad feeling” about any B+E scheme.

Those who fail believe they can handle anything the plant has hidden inside. They are wrong.

### Disguise Won't Work for Long

Gaining access to the plant as a worker there is difficult, if not impossible, and even then, it will ONLY work for one Agent — anyone trying to bluff their way in with a bunch of people in tow (even if they have the proper ID) automatically fails.

The first step is to capture and replace a Duxbury Plant worker *before* they go to work, and make a successful DISGUISE roll. Unfortunately, everyone at the plant knows everyone else. The only possibility is to hit a lucky patch, make a successful DISGUISE roll and second, get a recently hired Brownshirt at the gate. Even then, the Agent must make a FAST TALK roll to make it past the gate.

(If an Agent is discovered at the gate, it's highly likely some sort of armed conflict will escalate. From there, it's a single step towards a Raid, see page 76).

Even then, the trouble is just beginning.

Next, the Agent must pass through one of the “flashing” rooms, where weaponry and surveillance equipment *will* be discovered. This automatically activates the lock-down mechanism, effectively trapping the Agent in a bulletproof cell to be dealt with at HE employees' leisure.

Inside the gate, at each door, and with each person the Agent runs into, the chance of discovery rises; a LUCK roll must be made. However, each time this occurs, the Agent's LUCK is reduced by 1d10%.



When it hits 0, discovery *will* occur, and an Agent on the inside will get a distinct feeling of running out of time.

Smart Agents will cut-and-run, heading with due haste back towards the front gate. Those foolish enough to continue *will* either be captured or killed in a shootout (see page 75 for more details).

### Distraction It Better Be Big!

Nothing short of a huge explosion/fire will gain the agents a few minutes of confused reaction at the Duxbury Plant's front gate.

Large explosions/fires are a good way to draw much of the gate staff away from their posts, as well as bring in local firemen to provide a bit of unintended cover for Agents on the prowl. The prime target, of course, are the various vehicles in the blacktop parking lot — they're ideal explosives.

During a successful distraction event, all Brownshirt detection rolls are -10%.

The Brownshirts dispatched to investigate such a ruckus are clever men. A ruse will quickly be sniffed out (every 1d6 minutes following a distraction event, a Brownshirt can make an IDEA roll. On a success, the distraction is immediately reported as a feint over the radio net).

If the distraction is reported, everyone in the facility goes on alert, and Agents will have no choice but to shoot their way in (or out). See page 75 for more details on a Brownshirt combat detail.

### B+E Risky

Simply breaking into the facility is a sure fire way to lead to conflict — the place is quite simply one of the most guarded corporate sites on the planet (see page 69 for more details).

Agents with some experience (SNEAK skills over 45%) can see from a glance that it's no easy matter to get in undetected.

Those without such skills might mistake the site as a run of the mill factory grounds (make a halved LUCK roll to think otherwise).

Those foolish enough to simply show up after dark with a bolt-cutter, some firearms and a map will rapidly find themselves detected, stalked and quite possibly killed by a Brownshirt detail.

At night, Brownshirts will shoot first and ask questions later; confident that any evidence can be

perfectly disposed of in one of the various “whens” on the other side of the gate.

Agents should not underestimate the fervor of those in the plant.

Clever and skilled Agents might be able to make it to the buildings (make two SNEAK rolls — any failure trips a motion sensor/light and attracts a Brownshirt team. See below for more details).

## Brownshirt Tactics

At the front gate, or when on regular duty, the Brownshirts look much like any other security detail, but when there's trouble (particularly at night) they come running with less than conventional gear.

All Brownshirts are regularly equipped with handcuffs, a spray can of mace, a flashlight (also usable as a club) and a standard Glock pistol. They wear a heavy leather belt which stores their equipment as well as their radio, which has a threaded earpiece/microphone that sits in their right ear, making communication only a matter of speaking — no keys need be triggered. There are five main details for Brownshirts, listed below.

### Gate Team

This team of 9 Brownshirts man the twin buildings at the main entrance of the plant. Nearly all are armed with Glock pistols, though two on duty carry Mossberg shotguns.

They are level-headed and when necessary, cold-blooded, vacillating between distant courtesy and vicious combat at the drop of a hat. They have a way of taking command of a situation. Anyone interacting with a Brownshirt off-duty can make a PSYCHOLOGY roll. Success indicates detection of their shared military background.

### Patrol

These small teams of up to 3 Brownshirts patrol the grounds of the facility day and night. The only portion of this patrol with a single individual is the Brownshirt sent to the parking lot to catalog cars.

### Scout Team

Any disturbance in the wire at night that is unidentified calls in a Scout Team. This consists of 3-5 Brownshirts kitted with night vision gear (+10% to SPOT HIDDEN rolls), as well as automatic machine pistols.

Scout Teams are always dispatched first, to identify possible targets (just in case it's some kids from town having fun). Once the targets are located and identified (usually without the targets even knowing they've been spotted), their position is reported to the security HQ. If the incursion is something mundane (an animal, some kids from town) the Scout Team intercepts or scares them off.

### H+K Team

Hunt and Kill teams have never been used, but their existence is testament to the conflagration all in the plant believe is coming. Training for H+K teams is extensive and occurs once every week at night (those watching the plant 24/7 can make a halved SPOT HIDDEN roll to detect these field exercises).

These details of up to 10 Brownshirts wear night vision gear and carry fully automatic and silenced MP5's. When an H+K team is dispatched, it is only on the command of Jim Avary or William Lassiter.

## The Raid

### A Warzone in the Making



There's nothing like a raid to spread information through the various agencies in the government. Agents with any common sense will avoid this option like the plague, since it's pretty obvious something inside the plant is just not right.

The last thing a clever Agent wants is to alert *more* Federal agents to the mysteries of the mythos; calling down the hammer of a raid on the Duxbury plant is an ideal way to do so.

The threat of mythos-contamination goes even further than simply alerting some people in the dark about the reality of the supernatural; it risks alerting MAJESTIC to the existence of the gate and the history of HE. And MAJESTIC has no qualms in completely steam-rolling actual Federal agencies.

There are three ways to go with a Raid:

#### Fake Raid

##### “Certainly Officer, Come On In... *Get him!*”

Agents who attempt to exploit the isolated nature of the plant and the general public's fear of the authorities can attempt to stage a “Fake Raid” — by gathering a bunch of Agents together, whipping up some fake warrants and showing up at the front gate. Anyone

Needless to say, HE didn't survive this long by being stupid; when the Agents arrive they are detained at the front gate while Jim Avary is alerted.

Brownshirt guards are polite but insistent: the Agents must wait until Avary comes down.

If the Agents try to muscle their way in, guns are drawn. Brownshirts will not fire first, but will return fire, confident taped evidence of the numerous cameras will back up their story. They will do anything necessary to keep Agents out of the factory.

Alerting Avary is just a stall tactic — in fact, Avary uses this hiatus to contact various legal firms, local politicians and others trying to get to the bottom of the “raid”. A “fake” raid will quickly be discovered. If this occurs, have the group make a LUCK roll (lowest LUCK roll in the group).

Those who fail are invited in, after a brief pause. (a SPOT HIDDEN roll reveals the Brownshirts listening in their ear mike).

Once inside, the Agents are escorted to Building A, there, a contingent of 20+ well placed shooters wait for the Agents in ambush.

#### Locals

##### “What the Hell Kind of Guns Are They Shooting?”

Somehow suckering local law enforcement into a raid *is* possible, though difficult. The money that the company has brought to Duxbury has literally kept it on the map. The Agents will have to provide extensive evidence that something terribly dangerous is going on behind the closed doors of the Duxbury plant.

Nothing short of implication of a murder, terrorism or some sort of looming catastrophe will rouse local officials into getting a warrant and entering the plant.

This type of disinformation campaign not something entered into lightly — it requires significant work on the part of the Agents.

However, this is an *extremely* poor plan. Unfortunate Agents leading such a raid will find themselves hopelessly outgunned. When the Brownshirts break out the fully automatic, silenced H+K's, any sheriff's deputy worth his salt will duck and cover.

No ground will be gained through such a raid, and it will lead, precipitously, towards a full-on Federal raid.

#### Feds Far and Wide

##### “Waco Part II”

Simply breaking into the facility is a sure fire way to have it end in gunfire, flames and death. As well as a great way to draw in dozens of federal agencies, who up until the Duxbury plant showed up on CNN, had better things to do.

A raid can be called by nearly any type of agency, given enough lead-time. Common ploys might be an IRS raid (due to the gold being smuggled by the company), an EPA raid (searching for toxic waste

and or biological dangers), or even an FBI raid (looking into the strange deaths some plant workers have suffered).

When the hammer of the Federal government drops on the plant, it does not fold. Instead, a fire-fight of epic proportions erupts; causing deaths on both sides.

While this firestorm burns, it is possible — depending on the situation — for Agents to run and gun their way in. Notably, what they find is a gun behind every door, and employees out for Fed-blood.

Only the most careful, fast and accomplished Agents will survive such a raid. Those who wait for the situation to stabilize will instead find only a charred and smoking ruin of the plant.

Those Duxbury personnel that can make it to the gate room, escape into the past before wired thermite charges are detonated, erasing the gate, the facility and any who remain in it from the face of the earth.

For nearly five-years, the company has prepared for such an eventuality. As far as their odd-world-view goes, many in the world must already have been replaced by serpent-men like Hunt. It would only be a matter of time before their kind asserted their superior technology and conquered the globe once more.

### The Realities of a Raid

Agents with little or no experience in a raid (Federal or otherwise) will find themselves woefully out of their depth in the event of a raid on the Duxbury plant. If the raid is Local, the Agents will be in charge, but this is not exactly ideal, considering such a raid is doomed to failure.

If the raid is Federal, Agents will have to jockey for position on the “go team” — those individuals tasked with organizing and executing the raid. Otherwise, they will be pushed to the periphery, where information is hard to come by. (Make a LUCK roll, or be forced to the group of “outsiders” still technically associated with the raid, but without any real power).

#### Preparation

Any raid is a huge undertaking. Local authorities will muster up more than twenty law enforcement personnel from the area, armed with shotguns and pistols. Their HQ will be an old box van with a radio set-up used as an emergency vehicle by the local police. During this build-up (which takes more than 24 hours), it is likely that news will travel back to the plant that the local authorities are up to something.

Agents should make a LUCK roll. Failing means that the Duxbury plant is on alert when the authorities arrive (though they seem normal).

A Federal raid is an epic display of the terrible power of bureaucracy. Dozens of trucks, hundreds of personnel, a half-dozen helicopters, and enough weapons for an army will arrive suddenly, unfolding around the plant in less than two hours. Following them, hundreds of news crews from all over the world, like fleas on a dog set up an impromptu squatters camp, waiting for blood.

#### Negotiation

Once it becomes evident to the Duxbury personnel that the authorities (Federal or Local) mean to enter the plant, the gloves come off. As long as is possible, the gate personnel attempt to keep the authorities uncertain and at a distance. In either case, no real negotiation will go on without an exceptional idea on the part of the Agents.

#### Assault

As is noted above, assault is a deadly mistake that many groups will make. Locals will be hesitant to lead such a raid, and must be goaded into executing one. Feds, however, have no such qualms. They are arrogant and feel a stand-off at a local electronics plant on CNN makes them look ridiculous.

This arrogance will cost them in blood.

# Hostages

## A Decent Bet

DELTA GREEN has been known, in its time, to resort to blackmail, murder and even kidnapping. It is surprisingly easy to kidnap nearly anyone, given some research, the proper timing, and enough hands to make it happen. However, the two main targets of a kidnapping in this investigation — CEO William Lassiter and Jim Avary, Duxbury's head of security — are no ordinary people.

If the Agents aim to kidnap some nameless Duxbury employee, that should be easy enough given some preparation (see "Walter Weeks" below on page 82 for an example target), however, if the Agents go for Lassiter or Avary, they better come prepared. And no level of preparation will make it a squeaky clean operation; there are just too many warm bodies involved — warm bodies carrying guns.

### Jim Avary Shoot First, Etc. Etc.

Jim Avary is an interesting man. He's not easily tailed without noticing something is amiss (have him make a LUCK roll for each day of surveillance, on a success, make the Agent monitoring him roll vs. an appropriate skill or be detected).

Avary has been around the block more than once, and has something going for him that most criminals do not: an absolute belief in what he is doing. His crimes are not motivated by greed, but by conviction, and conviction is a very dangerous thing. Avary is certain Lassiter is the last and best hope for humanity. He will do ANYTHING to protect Duxbury's secret, and has, in the past, sanctioned murder to keep the conspiracy alive.

Avary is selfless in all the best ways. Capable of extraordinary feats of bravery in the face of certain death, and experienced in many situations from the battlefield to the boardroom. In short: he would be an ideal DELTA GREEN Agent, as such, he is exceedingly dangerous.

Avary lives in Duxbury in a small, modest two bedroom house, he drives an average car (a Toyota) and has no flashy "bling". He doesn't even dress in suits, opting instead for slacks, a button-down short-sleeved white shirt, and a beige windbreaker with an obvious gun-bulge. His house and car are



not protected by security systems. Avary travels light. He carries a fat-wallet however, filled with business cards, receipts and other chaff, but little cash. In it, however are two photographs. One of a young girl in the 1970's (his daughter, Imogen), and another of the same girl, now grown, with two children of her own (his grandchildren).

Avary is polite, curt and generally speaking, happy. He is seen in town from time to time, and is considered friendly by most.

Avary drives his car to and from work (often staying over at the plant) and sleeps at home. He takes all his meals at the plant. As such, the house is a seamless coda — it has no relevant information pertaining to HE.

However, there are hints of Avary's military past and a family life. A small cigar box in a bedside table contains a dozen or so photographs, his Rangers' patches, and, in a small plastic bag, a Silver Star (marked with Oak Leaf clusters, indicating an Army decoration).

Two photographs show a young Avary training at Fort Benning in the late 1960's, several shots show Avary with a blonde woman, and four photos show Avary the ground in Vietnam. The remaining two photographs show a child, at less than a year and later at the age of 2. The back of each of these photos is marked "Imogen Rachel Avary".

This is Jim Avary's only weakness; his daughter Imogen Grant (36 years of age). Agents who do their due diligence can locate Imogen Grant née Avary in a matter of minutes, with access to a police database.

She is the one lever with which the mystery of the Duxbury Plant might be laid wide.





### **Imogen Grant Née Avary** **Innocent Bystander**

Imogen is a divorced mother of two living in San Diego California. She talks to her father perhaps once a year, but he sends her a monthly check like clockwork. This money (which is substantial) has allowed Imogen to live in the rather upscale neighborhood of Bonita, twenty minutes southeast of downtown in a large finely appointed house. She has a regular schedule moving her two young children — a boy and a girl, Heather (3 years of age) and Michael (5 years of age) — between day care, school and home. Imogen works three days a week at a physical therapists' office in San Diego as a receptionist. Her schedule is exact.

Her house is large and on the edge of a large park (the Sweetwater Reservoir Park), making it an ideal location to hold someone indefinitely. If the Agents are smart, they will grab the family at the beginning of the four days of the week Imogen does not work (Wednesday through Sunday). Excuses can be made for the children's school and daycare (an illness, family death). Clever Agents can have up to five or six days without a single soul worrying about Imogen or her children.

She is an easy target, though those unused to such criminal activity must make a SAN roll to attempt such an act. Those failing suffer 1 SAN point damage from kidnapping an apparent innocent. Extremely callous Agents might instead snatch a single child from Imogen, and use her as a conduit to

get Avary's cooperation (doing so requires a SAN roll, failure inflicts 2 points of SAN damage).

A single phone call to Jim Avary from his daughter under threat is enough to turn his convictions on their ear, and have him working for DELTA GREEN within minutes. He is a strong man, but he can't stand the concept of his daughter or grandchildren suffering. He will do anything to prevent any harm coming to them. This chain of events allows a straight shot into the plant, Avary can gain access to any portion of the plant, including the gate and Ahmed, and can bring others along with him. He is absolutely trusted by the staff, and his word is law.

Still, Avary is a risk-taker, and if he sees any method of duplicity that might free his family, he will take it. Whether this means sending the Agents through the gate into some distant time, instigating a shoot out in a well-defended portion of the plant, or even scrambling a team of Brownshirts to San Diego to spring the family, if not monitored at all times, Avary will attempt one of these plans.

If he attempts such a plan and fails however, and the threat is reiterated, he will fold to the will of the Agents. Especially if the Agents in San Diego make it seem like something happened to one of his grandchildren.

### **William Lassiter** **Ready to Die**

William Lassiter, CEO of Hunt Electronics, is a man convinced his cause is right — he is the leader of HE, and particularly the Duxbury Plant. He is also selfless, to a point. If he feels he can stall an inevitable discovery of the gate by government forces, he will do so; even putting his life on the line.

Lassiter lives in the largest house in Duxbury, situated on a hill overlooking the plant (called simply "the house" in town). The mansion was built in 1988 at his specification, and finished in 1991, but since that time, Lassiter has spent little time there.

About once or twice a week Lassiter and his entourage of men and cars travel from the plant to the mansion; there, Lassiter spends a day of downtime before returning to the plant. During these periods, Lassiter reads correspondence, collects notes on his beliefs through research, and reads. Sometimes however, he doesn't return home for weeks at a time (those waiting for such a journey can make a LUCK roll, on a success, Lassiter makes the trip).

There jaunts are the only time he is off the plant property. He has long since set up a proxy-voting system for himself at the HE board meetings, and he teleconferences to many of them; when he has the time.

In the mansion, or on the road in or out of the mansion is the only place Lassiter is completely exposed. Even then, he is heavily guarded.

### Entourage Armed to the Teeth

About half the time, Jim Avary runs Lassiter home himself, along with a half-dozen Brownshirts loaded into a Lincoln Town Car and a Suburban Van. The two cars run single-file at high speed through the town; most of the time either very early in the morning or late at night.

They are never harassed by locals. Being stopped by police for speeding is unheard of, and everyone knows who the cars belong to.

If Avary is with the group (50% of the time), and some attempt to pull the cars over is made by authorities (perhaps as a ruse by DG Agents), the Suburban containing the Brownshirts will pull over to deal with the law, but the Town Car will continue onwards to the mansion.

If the cars are attacked, gunfire will rapidly erupt. Brownshirts will produce automatic machine pistols, as well as Mossberg shotguns loaded with buck-shot and begin firing at any attackers.

If the group is on the way to the mansion when such an attack occurs, they do their best to loop around and head back. Also, such an attack puts the entire Duxbury facility on alert from that point onwards (-10% from all relevant breaking and entering rolls by Agents).

If the group is ambushed in the parking lot of the Duxbury Plant, every round of combat adds 10% to a generic LISTEN roll; on a successful roll, 1d8 Brownshirts armed with shotguns arrive to join the fight. Once the plant is aware of such a conflict, Brownshirts keep coming, eventually flanking and killing the Agents easily.

### The House Surrounded

When Lassiter is at the mansion, a half-dozen security personnel (six of the Brownshirts) walk the grounds. They do not enter the house unless there is a problem. Two guard the main entrances (front/back door and garage), while four patrol the 1-acre lot of land looking for trouble.





This group is keyed in on a specific radio frequency (different than that of the plant) and keep their weapons concealed unless needed. They check in with one another at 25-minute intervals.

Inside the house, Lassiter is occasionally visible, puttering around the house in a robe and slippers, sipping a heavily iced drink, and reading books, paperwork or somesuch.

Lassiter often spends time in his basement, where he has a specially built climate controlled walk-in safe containing his collection of rare books and artifacts (notably, this safe is large enough to hold nearly 10 people for some time).

In this area is Lassiter's journal, an in-depth explanation of what he believes Arthur Hunt was, what "it" was working on, the truth behind the Duxbury Facility and its purpose, as well as tantalizing hints at the "offsite" location at the Duxbury Plant (all in all, reading this document takes 2 days and inflicts 0/1 SAN, adding +1% Mythos skill).

Getting in the house requires the removal of one of the two main Brownshirts at an entrance. Doing this silently might prove difficult; the most certain method is very unconventional (a heavily silenced distance weapon).

Keep in mind if a radio check-in passes without all reporting, the group will converge on the house.

Once the sentry is removed at an entrance, the next step is getting inside. The back door is the easiest, with small glass windows allowing a quick B+E with a successful LUCK roll.

Otherwise, a lock needs to be picked with the appropriate skill, this usually takes 10-minutes or more, depending on skill level.

Once inside, it is important to immobilize Lassiter as quickly as possible. If Lassiter is given a moment to react, he will either come out shooting with his small caliber pistol (drawing the Brownshirts) or rush downstairs and lock himself in the walk-in safe.

Once Lassiter is secured, Agents need to get out of the area. Doing so is relatively easy, as long as Brownshirts don't know anything is going on. Hijacking the Suburban is the best option, and simply driving out of the location at high-speed is possible.

The Brownshirts will not fire on the group as long as they are in possession of Lassiter.

## CEO Lassiter A Human Key

Lassiter is brave, but not foolish. Once captured, he will offer little in the way of resistance. He will answer monosyllabically in response to nearly any question; offering more detail only if threatened with violence.

Lassiter will only reveal the existence of the gate if subjected to serious damage (1d6 HPs or more), and will fill his statements with misdirections and lies, so that even when he is telling the truth, it is difficult to discern what he is actually saying.

Lassiter's disappearance will no-doubt be discovered very quickly by Duxbury personnel, but no police report will be filed. Instead, Avary waits for ransom demands at the plant.

When he hears what the Agents want (namely, access to the Duxbury Plant), he is uncertain, and spends time stalling, negotiating and running in circles. Any direct threat on Lassiter's life, or — even more useful — a demonstration of the threat on his life (inflicting harm on Lassiter costs 0/1 SAN) makes Avary fold immediately, offering the Agents anything they like.

In this situation, Avary is truthful. He lacks the leadership abilities to run the conspiracy, and the "offsite" location is not ready to become self-sufficient yet. He will do anything to get Lassiter back — including attempting to induct the Agents into the Duxbury conspiracy by revealing the truth.

Re-entering the plant with Lassiter guarded offsite is the smart move; attempting to enter the plant with Lassiter in tow is disastrously foolish. Agents who do so will rapidly find themselves inside the plant under the guns of twenty men.

Agents who re-enter the plant without Lassiter will call the shots, and Avary will be both cooperative and pleading, in an attempt to show the Agents the level of threat the world is facing.

During this time, Avary is attempting several things. One: if he knows the identity of the Agents, he is trying to make a counter-move by kidnapping someone equally important to that Agent (a family member etc...). Two: he is using information he has on the Agents to track their cell-phone activity.

If Agents are sloppy, this may lead a strike-team of Brownshirts turning up at the offsite location where Lassiter is being held attempting a possible

rescue. While if Agents are slow, this might end up with a hostage trade: an Agent's loved-one for Lassiter.

## Walter Weeks Just Another Employee

A good example of an average Duxbury Plant employee is Walter Weeks — a prime target for kidnapping. Mr. Weeks is a nondescript white male — a professional chemist — who has spent the last ten years of his life as a member of the Duxbury community. Weeks lives on the outskirts of Duxbury in a small cottage with an adjoining farmhouse; in this farmhouse, Weeks pursues his hobby — restoring vintage cars. His high pay has made it possible for him to buy and restore 1950's and 1960's roadsters for resale for some time.

There are no clues or valuable possessions at this house that point to the workings of the Duxbury Plant. All that work stays inside his lab at Building B.

Weeks works on chemical samples brought back through the gate from "Offsite" searching for traces of valuable substances like gold, silver and platinum; he is well aware of what goes on at the plant, and has seen Ahmed twice. Weeks is a believer in the cause, and is willing to do nearly anything for it, as long as it doesn't involve violence of any sort (especially towards him!)

In fact, Weeks is a pacifist (some might say coward) and will fold like a wet noodle when exposed to any sort of threat; hollow or not. He will spill all information he has; which is this:

1. Duxbury has constructed a gate to the past using alien technology. Through it, people have moved back and forth through time, to a period in the distant past. Weeks doesn't know what period they are traveling to. But they have traveled to other time periods as well.
2. This has been going on since sometime in the 1980's. A permanent base has been constructed at some point in the past, and millions of dollars and dozens of personnel have been sent back to populate it.
3. The company has an actual alien held on the premises. This is beyond dispute.
4. The company is the only force in the world that knows of the upcoming threat. These "aliens" can assume perfect human form, and have infiltrated human society.

5. Weeks confesses he was hired to locate valuable minerals in rocks recovered from the other side of the gate.

These revelations might come as a shock to some Agents, but past these startling statements, Weeks is of little use. He is certainly not someone the company will risk themselves for, and if he's used as a hostage, Lassiter or Avary will try to turn such a predicament into a trap. They will pretend Weeks is far more valuable than he lets on (detect this lie with an IDEA roll) and offer to trade him for money or access to the plant.

Such a trade, obviously, is a trap, with a dozen heavily armed Brownshirts laying in wait to meet the Agents. By the time the first shots are taken, it is likely Weeks and most of the Agents will be dead.

Using Weeks' ID badge off hours, or attempting to impersonate Weeks is a possibility, though a slim one (see *Through the Wire* on page 74 for more details).

If the Agents do manage to gain access using Week's badge, it gives them access to all of Building B, except for Ahmed's cell, and the biological samples area.

Even if the Agents manage to get in using such methods, it remains highly unlikely they'll be able to get out in the same manner.



# Negotiation

## The Surprising Best Bet



DELTA GREEN is less than forthcoming with the information it has gathered over the decades — even to its Agents — and Hunt Electronics is no different. In fact, the two groups have more than a few things in common.

They are both small, dedicated groups fighting the supernatural in their own way. HE's Duxbury Plant represents something different however, breaking the unspoken rule of DG — don't get mixed up in the mythos. HE has done the opposite of search and destroy, they've gathered and exploited. It is the viewpoint of HE that this experimentation and exploitation is necessary for the survival of mankind.

Still, those in control of HE are not beyond reason. They are altruistic, driven, selfish and can be deadly, but what they do, they do because they believe in their cause.

Negotiating with a group as paranoid, well-armed and resourceful as HE will not be easy, but success means a huge victory and a possible peaceful resolution to the situation.

### Getting the Ball Rolling Not Too Easy

Communications on the level necessary to gain a parlay between DELTA GREEN and HE can only go through two people: Jim Avary and William Lassiter. These two men are incredibly secretive and clever. They will talk circles around most Agents, and those who play coy will find themselves lost in a maze of pointless conversation.

Avary's knowledge of the horrors that haunt the Earth is limited only to Serpent Men and their odd, alien science. As such, only bringing up something directly dealing with this particular race will elicit a response. Even then, he will play it cool, leading the Agents on to probe their knowledge on the subject. After all, as far as he's concerned, the Agents could be working for the Serpent Race.

Lassiter is the key. His knowledge of the occult is significant, and wise Agents will broach subjects specific to his interests. Those who mention the Necronomicon, or other mythos concepts espoused in it (Cthulhu, Irem, R'lyeh etc...) can make a LUCK roll.

A successful roll indicates Lassiter is listening openly to their ideas, and will give them small positive indications that he's aware of what they're talking about.

Once this channel of communications is open, the Agents may work to enhance it; as long as nothing troublesome occurs in the meantime. The moment something negative occurs involving law enforcement past this initial contact, the lines of communications shut down, and no further negotiations are possible.

### Opening the Lines Requires Trust

The next step in successful negotiation is offering HE some sort of olive-branch. Sending such a request up the command chain to A-Cell could elicit many responses; but hopefully, it will move A-Cell to send in a Go-Between, some intel to trade, or open a direct line of communication between A-Cell and Lassiter himself.

This should be no easy task — Agents need to state their case fervently to even get a response from A-Cell. Nothing short of "HE seems to have constructed a Gate based on mythos technology" will elicit any clear response. Even then, it might take some time for a response to be forthcoming. Agents must be persistent, continue to feed info to A-Cell, and keep HE on the hook to get anything done.

### The Go-Between Calm and Clever

This anonymous man is in his mid-40's, and goes by the name "Michael". He will show up when sent in



by A-Cell, and take his cues from the Agents. He is there, he claims, to open a clear and trustworthy line of communications between HE and the conspiracy.

Michael is seamless. He drives a car rented by a shell company in Cincinnati that leads back to an empty office rental and faked credit card receipts. He carries a full array of perfectly faked ID in the name of Michael Green. Even his features and quiet voice seem somehow blank.

Agents clever enough to track his fingerprints will reveal he is Agent Michael Djmetriavic of the Chicago office of the DEA. In the conspiracy, he is Agent Otto.

Michael carries with him, a brown file-o-fax, and travels unarmed. He will not reveal the contents of the valise to the Agents in the investigation, saying that they are "eyes only".

In the valise are a series of files — each from a different service, era and region, detailing cases with any similarity to the strange story of Arthur Hunt. If all goes well, Michael plans to "share" them with Lassiter in the hopes of gaining good-will between the two groups, and establishing a common goal.

This outcome — HE joining with DG should be roleplayed out; and should be incredibly difficult to achieve.

### The Doppelgänger Papers

**Not all the papers in the valise report the same situation as Hunt's replacement by the Serpent Man, but at least two cases are nearly identical to it. The rest of the papers deal with all manner of horrors documented in official, Top Secret reports for various Federal Agencies, and even a translated French report from Algeria in 1948. 1 Day to read, inflicts 0/2 SAN, adds +1% Mythos skill.**

#### Contents:

1. A 1935 Army report of an incident during the construction of a Federal dam in southern Alabama. Soldiers on the scene report digging up a "coffin" and upon opening it, discovering the desiccated corpse of "something like a snake man", approximately 8 feet from foot to top of the head. The creature was classified and remanded to the possession of something called "P-Division".
2. A 1966 Air Force report of a pilot of a Douglas F-4 Phantom II who was "struck by a fast radar target", ejected and was found on the ground comatose. After a 3-week period of unresponsiveness, the pilot suddenly woke and went on a killing rampage, murdering four before being brought down by a hail of automatic gunfire. An autopsy revealed an "anomaly" — a 3 foot silver, red organ-like creature growing in his chest. These files are copies, and are marked MAJESTIC.
3. A 1945 report from American Army troops in Iran, dealing with a religious hysteria striking a small city in southern Iran. The locals were convinced that something they called *Nechustan* was killing livestock and the occasional person. After a Soviet soldier was violently murdered, a manhunt ensued, leading to a confrontation with a "dinosaur" in the mountains south of the town. The creature, which was shot more than four dozen times before it fell "seemed to look like a person — but only in flashes — when it fell, it was a reptile; a giant snake".
4. The translated French report from Algeria, 1948. The wording of the report is strange, almost indicating the odd problem listed within was dealt with before. Something vaguely referred to as a "skin-jumper" was hunted for eight months as it moved from identity to identity; finally, it was located and dispatched by French Colonial authorities.
5. A 1977 Navy report of a cutter — the USS Haight — reported missing in the southern Pacific. The ship was later located, adrift, abandoned looking as if it had suffered tremendous damage and repelled numerous attempts to board it. The logs spin a tale of an uncharted island occupied by a violent, small people called the "Tachon". The leader of these people was not human the log claims; instead, it was some sort of "fish man". The position of the island is marked, though the file claims no such island exists at that location.

# Inside the Compound

## Curiouser and Curiouser



Assuming Agents somehow gain unfettered access to the Duxbury plant, all manner of oddities await them inside Building B. For now, let's focus on the layout and number of buildings inside the fence perimeter.

### Structures

#### Count, Purpose and Location

Past the main gate, the interior area of the compound is all carefully maintained. It looks like any other corporate site in the world, except perhaps a bit cleaner than usual. Smooth, asphalt roads meander all over, connecting all buildings to one another. Sign-age clearly points the way to each building at each intersection.

The two main central buildings in the compound: Building A and Building B are identical, large industrial buildings built of corrugated steel, concrete, frosted gray windows, steel scaffolding and piping.

At first glance both buildings look nearly identical. The only difference is that Building B has what appears to be a large industrial incinerator jutting from the west side. The chimney from this incinerator is often spewing a thick, black smoke (mostly at night). It is through this incinerator — which is actually a series of incinerators leading up from an area near the gate — that Duxbury disposes of its biological samples.

Scattered around these two buildings are a smattering of smaller, more clearly purposeful structures.

Two small car-park like overhangs house a half-dozen golf-carts each, as well as a methane pump to refill them. Brownshirts and other personnel often

use these vehicles to cover ground in and around the plant. Notably, these areas are ripe for explosion — methane in pressurized tanks is notoriously flammable.

A heavy, but small building sits on the road towards the main buildings. The building has no windows, and is built like a bunker. The steel door sunk into its face is extremely sturdy (only an EXPLOSIVES÷2 roll will successfully breach the door). This is an emergency exit that meanders 155 feet down to the Gate level of the Building B.

A large array of electrical transformers are stacked, row on row in a fenced in area just beyond the main buildings. Anyone making an ELECTRONICS roll can see the transformers are built to carry a heavy load; of a level not usually seen in a factory.

This is Duxbury's own electrical relay station — constructed after complaints from the town were filed because of random brown-outs and black outs. Duxbury paid for special connection to four electrical grids in the area, which are switched through this sub-station to the plant. The load is now spread across four counties instead of the Duxbury sub-station.

Duxbury requires a huge amount of electrical power to run "Ahmed's" device — the hypergeometrical gate control apparatus. This means if this relay station is destroyed, the Gate is neutralized for a period of time dependent on the level of destruction.

A squat, two story concrete building with two entrances sits in front of the two main buildings like a sentry — this is the security office. The Brownshirts have all manner of men and equipment stashed in this structure, and Jim Avary's office is situated here. Anyone foolish enough to get into an armed conflict in this building is in for the fight of their life. If a breach occurs, dozens of Brownshirts will rush from this building armed to the teeth.

### Building A

#### The Ruse

Building A is a huge red herring. It is an incredibly detailed replica of a microchip production facility. This is the building toured by the rare press visits, and William Lassiter maintains a wholly convincing office in this building, as well as a full-time secretary here.

Large areas are hermetically closed off, and "require" anti-static suits to enter. In these areas, a convincing ruse of chip production continues on and on. In fact, anyone with an appropriate skill and some time to examine the process finds the chips are junk, and the production cycle is nothing more than a cleverly constructed loop.

When Building A is being visited, the area is overrun with personnel, looking purposeful and well-

directed. It is a wholly convincing illusion if one does not look any deeper.

If the Agents gain access to Building A without the plant's foreknowledge, it is a ghost town. Empty of personnel even in the middle of a normal work-day. Only four full time staff, including Lassiter's secretary, occupy the building when it is not acting as a diversion. In fact, little attention is paid to it, as long as the Brownshirts have no idea anything is going on. As such it might become a safe haven for Agents infiltrating the compound.

## Building B The Prize

Building B contains the heart of the secret which powers the Duxbury plant. Besides the huge area above ground, which contains dozens of research laboratories, storage rooms, security stations, offices and various amenities (rec-rooms, cafeterias, break-rooms, showers, dormitories and more), there are hundreds of rooms below ground, representing a series of airlocked rings descending down to the Gate itself.

This building is always crawling with personnel, and is always staffed by half of the Brownshirt contingent on duty.

## Oddities Above Ground Strange Storage

Anyone poking around the upper levels of Building B will soon find all manner of oddities stashed about. In various storage rooms and other areas, stacked boxes of MRE rations (Meals Ready to Eat) can be found. There are so many of these boxes that they are stored everywhere. Other bizarre finds include military-grade self-inflating white water rafts, stacks of ammo boxes filled with 30-06 rounds and 7.62 mm clips.

Stacks of small aluminum boxes containing sunscreen, water purification tablets, several doses of a multi-spectrum anti-biotic, sunglasses, insect repellent, a flashlight and a Glock pistol and holster can be found stacked on the ground floor, quietly in one corner. Just this stack is enough to outfit 170 people.

Several large crates on the ground floor as well are filled with components assembled to become a huge oil drilling rig (minus the shaft).

Also, near the main entrance, two nondescript canvas bags are filled with a hundred and fifty pounds of roughly hewn gold, silver and platinum ore. They're discarded to the side of a commonly used hallway as if they were filled with trash



## Down Below Getting Down and Dirty

Almost all entrances to the lower levels of Building B are tightly guarded. The only unmonitored access to be had can be found by entering from the surface's emergency exit building. This is no easy task. The door to this entrance is incredibly resilient and pressurized, and it sits, exposed in the middle of the compound. Breaking into it without some special plan will surely draw attention. Those who make it in find a complex series of stairs, refuge areas, and levels all hermetically sealed. These wind down all the way to the Gate level 155-feet below. This is considered an exit; and is one of the few oversights of HE — few would consider people entering through this passageway; though doing so is quite possible.

The only other entrance is a batch of three large, specially constructed elevators on the ground floor at the center of Building B. Access to this area is through a single set of airlocked doors. The room which surrounds the elevators is large (about the size of a school gym), but has a low ceiling. The entire room has been constructed to support huge pressure changes. Much of this room is taken up by stored materials ready to be moved "offsite", and a constant contingent of 3 Brownshirts wait here, monitoring traffic.

These elevators are specially fitted with airlock doors, various Nuclear Biological and Chemical countermeasures (Radiation meters, cleaner sprays, etc...) They are obviously cutting edge tech. Each can carry something as large as an economy car. These elevators are in constant motion, two bouncing up and down between the 9 sub-levels with various personnel, gear and equipment, all day and night.

The third elevator is reserved for priority movement, and only Lassiter, Avary, the Brownshirts and various medical crews have access to it by swipe card.

Occasionally, the elevators will lock down and various protocols will sound over the hidden speaker system spread throughout the entire building. Most of the time, this is a drill, but sometimes it's due to the detection of radiation, an unidentified viral sample, or even the accidental release of a temporal-alien specimen (most often an insect).

During these lockdowns all elevator movement is arrested, and each elevator is inspected by camera by the Brownshirts. Personnel on the elevators are asked their origin point, their destination and are asked to do a "eyeball check" of their clothing, any cargo and the elevator itself, looking for things that

should not be there. If Agents are detected during such a sweep, they will be held in the elevator for hours, while Lassiter or Avary decides what to do with them at their leisure.

## Nine Levels Fun and Games

There are nine sub-levels to Building B, the majority of elevator stops occur between Level G (ground) and Level 5 (Intel). The few elevator stops which go between Level 6 and 9 are very noticeable, because alerts are piped around the building on the PA announcing them.

### Level 1 Barracks (Nicknamed "The Rack")

This is a sprawling, maze-like floor filled with nearly one-hundred rooms all told. In each is an anonymous cot, a footlocker, a TV with video-tapes and DVDs and little else.

Many of these rooms (each of which is numbered, but not locked) contain clothing and everyday gear from people currently offsite in the lockers. This includes ID, keys and nearly everything else commonly carried.

People on this floor generally are either pumped up and excited (those ready to head offsite) or exhausted (just returning). In either case, there are few in the halls. Most are either sleeping, or moving to the Gate.

### Level 2 Mess/Rec Area (Nicknamed "Pool Hall")

This is a more modest level, it is perhaps a dozen largish rooms filled with foosball and ping-pong tables, video game machines and various work-out equipment.

A large communal shower is split in two between men and women, and a large cafeteria closes out the floor. This floor is generally bustling with activity; HE personnel letting off steam and just hanging about. Strangers will be quickly noticed here.

### Level 3 Medical (Nicknamed "Pee and Prick")

This is a large floor, more carefully laid out than the previous two. It prepares personnel for offsite trips, and gives general medical exams to every HE employee every month. It is surprisingly like a hospital

with similar lighting, paint, doors and such — but obviously, no windows.

Sometimes as many as two-dozen "patients" are on this level, being treated or examined by the fourteen doctors who work here in shifts. This floor is generally more laid back and sedate than those above it, and people tend to mind their own business here, so strangers might get along for some time without being discovered.

Thousands of medical records can be found here, including some of anomalous deaths in the factory; these odd files have two reports in each — what actually happened and what the authorities were told.

### Level 4 Storage

This is a large warehouse-like level. Various methane powered front-loaders move large boxes to storage bays, some stacked as high as twenty feet. This is a sparsely manned level, and less than three personnel are here at any time.

The equipment is more and bigger versions of everything discovered above, as well as crate upon crate of M-16A2 assault rifles, anti-tank weaponry, and more bizarre and incriminating things including plastic explosives, dynamite, a generator the size of a VW bug, high-tech radio equipment, a 23" telescope disassembled into pieces, an entire military grade field hospital broken down into twelve crates, and more.

Anyone poking around here for more than ten minutes comes to the rapid conclusion that somehow, HE is building an army.

Before something is moved offsite, it is moved here, cataloged and then deconned.

Intel is a small level. On it, a half-dozen support personnel handle all info coming in or going out to "Offsite". On the intel level tens of thousands of hours of logs record all offsite trips, discoveries and problems. This floor is the first stop of all Offsite personnel after Decon; where they spend hours spilling their guts about their experiences offsite.

### Level 5 Intel (Nicknamed "Interrogation")

This level is manned by non-military analyst types; and is easily taken by an armed force. It is considered so far down towards the Gate level that it is considered "safe". Access to Decon, The Menagerie and the Gate Level are able to be altered from the Intel level; making it possible to get to the "Secure"

levels without detection.

### Level 6 and 7 Decon (Nicknamed "The Tank")

This is a series of large, bathysphere like chambers where offsite personnel coming or going are subjected to cleansing, enemas, chemical scrubs, pressurized special atmosphere containment areas, bland diets and physical examination. It is the only "Level" that spans two floors.

Personnel heading "Offsite" often spend two or more days in isolation, suffering all manner of medical oddities to purge their system of any micro-biological oddities. Those coming back often find themselves held for much longer periods.

This floor is manned by a dozen personnel at a central control area; the floor itself is all "self-serve" — the personnel enter and administer treatments at the direction of the command personnel while being monitored on camera. When someone is granted a clean bill of health by the command crew, they're given a pair of white coveralls and booties to wear until they can get back up to the Barracks. Others, not yet clear wear medical garments.

### Level 8 Temporal-Alien Storage (Nicknamed "The Menagerie")

This floor contains hundreds of specimens of "Offsite" flora and fauna, as well as the inhuman creature known as Ahmed.

The main area is divided into four Biohazard 4 labs and adjoining suites of morgues, storage and more. These are the real thing; Racial biohazard suits, chemical scrubs and UV lights are required to enter any of the secured areas. Inside these labs, all manner of specimens from "Offsite" are dissected, cataloged and studied. Few, if any, are kept alive.

Generally speaking, teams work here in shifts, and there's a 30% chance the labs are totally unoccupied. If not, usually a team or two occupy one or two labs. It is almost unheard of for all four areas to be occupied at once.

Any Zoologist or Anthropologist who spends more than a few minutes looking at any of the computer terminals, or searching the files here will be floored by the list of species — 100% of which are known to be extinct, listed with various digital tags such as "full dissection", "captured and stored", "remains found".



ANYONE who makes it into any of the labs discovers hundreds of biological samples that are just plain out of time. Getting inside the labs requires following complex biological procedures — make a LUCK roll or a BIOLOGY roll if personnel are present, or an alert is sounded.

Ahmed, the Juvenile Serpent Man is kept in an isolated area past the main labs. Only six ID badges can gain access to this area, and it is sealed in a specially constructed vault.

Inside the vault is a plexiglas enclosure in which Ahmed has been confined for 21 years. The creature is sprawled in an "X" position permanently, due to specially designed restraints. This area is always occupied by a Brownshirt or doctor. Any entering without clearance (or Lassiter and Avary) will have to deal with them before an alarm can be triggered.

The creature is obviously ill, and is kept alive by invasive medical means. Simply seeing this creature costs 0/1d6 SAN. Ahmed is exceedingly clever. The moment the creature sees new humans — ones it has not seen before, it feigns a truly sickly condition, beginning to rasp and heave its chest.

No one has entered the cell in years; and all probes/treatment have been administered remotely. Those foolish enough to open the containment cell can do so. The restraints the creature is encased in seem very secure, and they are — for the "arms" and "legs". The head however, still has some mobility and an incredible reach. Like most snakes, Ahmed can distort its musculature to extend its head more than two feet outwards from its restraints, hopefully taking a bite out of a foolish Agent.

Another tack the creature may take is to assume one of its many memorized human forms, and beg the Agents to release him in various languages. Each Agent confronted by this illusion should make a IDEA÷2 roll. Those who succeed get a "bad feeling" whether they associate this with being discovered by HE security, or something besides Ahmed is up the Keeper.

If Ahmed manages to gain access to fresh, human blood, he will use his hypergeometrical abilities to release himself, and will kill his way through the plant towards the gate. If this occurs, DELTA GREEN may face a much greater threat than HE poking around in the past — Ahmed might gain an army of Serpent Men reinforcements from the past.

### Temporal-Alien Samples

- Hundreds of boxed, treated and pinned insect samples, including monstrous creatures nearly two feet long. Each is marked plainly with an identifying number and another marking: "~110mya", "~220mya", "Unknown". Anyone making a ENTOMOLOGY roll must make a SAN roll of 1/1d4 — every single one of these insects is extinct, and the "mya" indicates "Million Years Ago".
- A dead and dissected dinosaur about 1 meter tall, splayed on a table with all major organs exposed, it was quite obviously in full working order not too long before, and is not a fossil, or some amazing "frozen in ice" find. Any successful ZOOLOGY roll identifies it as an early dinosaur. A successful PALEONTOLOGY roll identifies it as an Eoraptor from approximately 230 million years ago. Anyone seeing this suffers 1/1d4 SAN.
- A large, humanoid creature covered in gray white hair; dead but untouched. It is approximately 2.2 meters tall, and shows characteristics of humanity and the Great Apes. The tag on its toe reads "Unknown Primate, ~1.1 mya". It is not readily identifiable, though any with medical training will see how important such a find could be — it seems to be the fabled "missing link". Testing for rigor indicates it has been dead for less than a day. 1/1d6 SAN.
- A large sinuous shape curled into an oversized body-bag. It is unfrozen, but stinks of chemicals. Inside is a 4.5 meter long sea-serpent like creature. Its face is vulpine; with a wide mouth of tiny, razor sharp teeth, and large, bulbous eyes. It is quite obviously not of modern Earth. The sticker on the bag says "Found in Nets, Day 3, Trip 0013, ~3.5 mya".
- A bulbous, plant-like bulging tube of rugose material approximately 1.2 meters tall sealed in a large specimen case. It is unlike anything any modern scientist has seen; all science rolls to identify it automatically fail. It is split into five sections, and each section extends an odd branch from the center. The top of the "thing" is topped by five tubes, which look like severed bamboo chutes, and sprinkles with small, pock like marks. This is a juvenile Elder Thing, discovered some 100 million years ago, apparently conducting experiments of its own. The most important thing about this sample is it's still alive — indeed, the group has found no way to kill it. Any foolish enough to open the cage on the apparently dead creature find it quite alive, motivated to escape and incredibly intelligent. 0/1d6 SAN.

## Level 9 Gate (Nicknamed "Off-site")

This final level underground is a maze of pressure locks, airlocks, huge, reinforced steel and carbon bulkheads and more. Colored lines meander on the ground and on the walls, leading particular groups through the maze of rooms.

This is a busy level. People come and go, many in odd jumpsuits, combat boots, gloves and helmets. Little attention is paid to unknown personnel on this level unless they make themselves conspicuous.

Following groups deeper into the level is the best method to find the Gate. As the Agents approach, moving through various rings of airlocks, the air pressure, humidity and temperature seems to shift. Near the center, humidity is nearly 80%, and the temperature is approximately 98 degrees.

Finally, if the Agents make it this far, they gain access to the Gate room, an enormous room the size of a concert hall, filled with equipment, personnel and the Duxbury gate.

Those familiar with the Hellbend gate will immediately recognize this gate — it is identical in every aspect (except it works properly). It also differs from the Hellbend gate in that when it opens a portal, the portal opens on both the transmission and receiving end, allowing two-way transit.

Next to the gate is a small, odd, wheel shaped device covered in Aklo writing. This obviously alien device is retro-fitted to a human constructed machine which seems to operate it — this is Ahmed's hypergeometric gate-control. Huge, thick power cables run from this device up into the ceiling of the Gate room. Without this device, the Gate is nearly useless to humans. Though it can still be activated, it only travels to the locations presented on page 21, Ahmed's device offers fine control of the device, as well as memorizing "safe" presets that are within human (and Serpent Man) tolerances. An easy way to disable the device is to steal this "tuner".

The Gate itself is rarely active, and "turning it on" requires a complex sequence entered into a computer. Unscheduled openings of the Gate automatically trigger alerts.

Those foolish enough to travel through a triggered Gate without a clear idea of their destination deserve whatever fate their Keeper can devise. Alternatively, if the Agents travel to the HE "Offsite" location, see FUTURE/PERFECT Part 4.



# Stats for Future/Perfect 3

## The Players

### Jim Avary Head of Duxbury Security

**Race:** Caucasian, **Education:** High School **Occupation:** Head of Security for the Duxbury Plant, **Age:** 62, **Height:** 6'1", **Weight:** 240 lbs, **Hair:** White, **Eyes:** Brown

**STRENGTH** 11 **SIZE** 18 **CONSTITUTION** 12  
**DEXTERITY** 16 **POWER** 13 **APPEARANCE** 10  
**INTELLIGENCE** 15 **EDUCATION** 8

**HP** 12 **MP** 13

**SANITY** 55

**IDEA** 75% **LUCK** 65% **KNOW** 40%

**DMG BONUS:** +1d4

**SKILLS:** Administration 25%, Computer Use 22%, Conceal 40%, Credit 80%, Cthulhu Skill 3%, Dodge 24%, Drive Automobile 55%, Law 12%, Listen 30%, Military Science 35%, Search 65%.

**LANGUAGES:** English (own) 100%, Vietnamese 33%

**ATTACKS:** Punch 45% (1d4+DB)

Colt .45, 60% (1d10+2)

Shotgun, 80% (4d6)

### William Lassiter CEO Hunt Electronics

**Race:** Caucasian, **Education:** B.A. Mathematics, UPenn **Occupation:** CEO, Hunt Electronics, **Age:** 60, **Height:** 5'8", **Weight:** 190 lbs, **Hair:** White, **Eyes:** Green

**STRENGTH** 9 **SIZE** 10 **CONSTITUTION** 11  
**DEXTERITY** 11 **POWER** 13 **APPEARANCE** 12  
**INTELLIGENCE** 17 **EDUCATION** 21

**HP** 11 **MP** 13

**SANITY** 40

**IDEA** 85% **LUCK** 65% **KNOW** 105%

**DMG BONUS:** +1d4

**SKILLS:** Administration 31%, Chemistry 12%, Computer Use 31%, Cooking 10%, Credit 100%, Dodge 13%, Drive Automobile 39%, Ethics 31%, Fast Talk 60%, Law 25%, Persuade 75%, Psychology 55%, Search 60%.

**LANGUAGES:** English (own) 105%, Latin 20%

**ATTACKS:** Punch 51% (1d4+1d4)

.38 Snub Nose Revolver 60% (1d10)

### Walter Weeks Forgettable Chemist

**Race:** Caucasian, **Education:** PhD Chemistry Columbia University, **Occupation:** Author, **Age:** 40, **Height:** 5'6", **Weight:** 180 lbs, **Hair:** Black (graying temples), **Eyes:** Green

**STRENGTH** 6 **SIZE** 11 **CONSTITUTION** 18  
**DEXTERITY** 10 **POWER** 4 **APPEARANCE** 13  
**INTELLIGENCE** 13 **EDUCATION** 20

**HP** 12 **MP** 4

**SANITY** 20

**IDEA** 65% **LUCK** 20% **KNOW** 100%

**DMG BONUS:** -

**SKILLS:** Accounting 12%, Chemistry 59%, Computer Use 61%, Credit 55%, Dodge 17%, Drive Automobile 45%, Restore Automobiles 55%, Search 32%, Writing 40%

**LANGUAGES:** English (own) 100%

**ATTACKS:** Punch 30% (1d4)

### Imogen Grant Née Avary Innocent Bystander

**Race:** Caucasian, **Education:** B.A. English Literature **Occupation:** Mother, **Age:** 31, **Height:** 5'5", **Weight:** 110 lbs, **Hair:** Brown, **Eyes:** Blue

**STRENGTH** 7 **SIZE** 10 **CONSTITUTION** 12  
**DEXTERITY** 14 **POWER** 10 **APPEARANCE** 12  
**INTELLIGENCE** 12 **EDUCATION** 18

**HP** 11 **MP** 10

**SANITY** 50%

**IDEA** 65% **LUCK** 50% **KNOW** 90%

**DMG BONUS:** -

**SKILLS:** Art (Literature) 21%, Computer Use 20%, Drive Automobile 50%, Mothering 70%.

**LANGUAGES:** English (own) 90%.

**ATTACKS:** None

## Average Brownshirt Hired Gun

**Race:** Varies, **Education:** Military Background  
**Occupation:** Former Military Personnel **Age:** Varies, **Height:** Varies, **Weight:** Varies **Hair:** Varies, **Eyes:** Varies  
**STRENGTH** 14 **SIZE** 13 **CONSTITUTION** 18  
**DEXTERITY** 14 **POWER** 15 **APPEARANCE** 7  
**INTELLIGENCE** 16 **EDUCATION** 10

**HP** 16 **MP** 16  
**SANITY** 75%  
**IDEA** 80% **LUCK** 75% **KNOW** 50%  
**DMG BONUS:** +1d4

**SKILLS:** Computer Use 25%, Conceal 50%, Credit 50%, Cthulhu Skill 1%, Dodge 30%, Drive Automobile 60%, Explosives 35%, Law 25%, Listen 40%, Military Science 35%, Search 70%.  
**LANGUAGES:** English (own) 50%, Smattering of other ethnicities have other languages  
**ATTACKS:** Punch 60% (1d4+1d4)  
Glock 60% (1d10+8)  
Mossberg Shotgun 40% (2d6/3d6/4d6)  
MP5 55% (1d10)

## Anonymous Hit-Man Silent Mechanic

**Race:** Varies, **Education:** Varies **Occupation:** Professional Killer **Age:** Varies, **Height:** Varies, **Weight:** Varies **Hair:** Varies, **Eyes:** Varies  
**STRENGTH** 13 **SIZE** 15 **CONSTITUTION** 13  
**DEXTERITY** 14 **POWER** 7 **APPEARANCE** 15  
**INTELLIGENCE** 18 **EDUCATION** 7

**HP** 13 **MP** 7  
**SANITY** 35%  
**IDEA** 90% **LUCK** 35% **KNOW** 35%  
**DMG BONUS:** +1d4

**SKILLS:** Computer Use 35%, Conceal 60%, Dodge 40%, Drive Automobile 45%, Explosives 40%, Law 10%, Listen 40%, Throw 35%.  
**LANGUAGES:** English (own) 35%, Various other languages  
**ATTACKS:** Punch 55% (1d4+1d4)  
Knife 55% (1d4+2+1d4)  
.303 Lee Enfield Rifle 70% (2d6+4)  
Hand Grenade Throw% (4d6)

## Ahmed Juvenile Serpent Man

**Race:** Serpent Man **Age:** 1.1 million years,  
**Height:** 6'8", **Weight:** 190 lbs, **Hair:** None, **Eyes:** Blue  
**STRENGTH** 10 **SIZE** 9 **CONSTITUTION** 10  
**DEXTERITY** 13 **POWER** 14 **APPEARANCE** --  
**INTELLIGENCE** 18 **EDUCATION** --

**HP** 10 **MP** 14  
**SANITY LOSS** 0/1d6 SAN  
**DMG BONUS:** 0  
**ARMOR:** 1-points of Scaly Skin

**LANGUAGES:** Aklo (own) 100%, Aramaic 24%, English 40%, Latin 25%, French 49%  
**ATTACKS:** Bite 35%, 1d8+ POT 10 Poison  
**NOTES:** Ahmed can assume the disguise of nearly a dozen humans it has consumed.

## Elder Thing Temporal Prisoner

**Race:** Elder Thing  
**STRENGTH** 20 **SIZE** 14 **CONSTITUTION** 20  
**DEXTERITY** 13 **POWER** 10 **APPEARANCE** --  
**INTELLIGENCE** 15 **EDUCATION** --

**HP** 17 **MP** 10  
**SANITY LOSS** 0/1d6 SAN  
**DMG BONUS:** +1d6  
**ARMOR:** 7-points of Rugose Skin

**LANGUAGES:** Elder Thing Language 100%  
**ATTACKS:** Tentacle 40% x5 (1/2 DB in Damage)